



DSE Genset®



DEEP SEA ELECTRONICS

DSE8660 MKII Operator Manual

Document Number: 057-259

Author: Fady Atallah



Deep Sea Electronics Ltd
Highfield House
Hunmanby
North Yorkshire
YO14 0PH
ENGLAND

Sales Tel: +44 (0) 1723 890099

E-mail: sales@deepseaelectronics.com

Website: www.deepseaelectronics.com

DSE8660 MKII Operator Manual

© Deep Sea Electronics Ltd

All rights reserved. No part of this publication may be reproduced in any material form (including photocopying or storing in any medium by electronic means or other) without the written permission of the copyright holder except in accordance with the provisions of the Copyright, Designs and Patents Act 1988.

Applications for the copyright holder's written permission to reproduce any part of this publication must be addressed to Deep Sea Electronics Ltd at the address above.

The DSE logo and the names DSEGenSet®, DSEATS®, DSEPower® and DSEControl® are UK registered trademarks of Deep Sea Electronics Ltd.

Any reference to trademarked product names used within this publication is owned by their respective companies.

Deep Sea Electronics Ltd reserves the right to change the contents of this document without prior notice.

Amendments Since Last Publication

Amd. No.	Comments
1	Initial Release
2	Added SNMP, Redundant MSC, Battery Chargers on DSENet, Additional Application Diagrams, New/Missing Display Sections and Parallel Operation Descriptions. Updated Bibliography, UL Requirements, J1939-75, DSENet Info, Protections, Breaker Operation in Manual Mode and FPE.
3	Updated to the V6.1 of the module software. Added the new MSC screens, New PLC Instruments screens, Simulate Injection Testing, Fault Ride Through, updates in the FPE & Running Editor...
4	Updated to module firmware V7, features include: Manual Bus Adjust, Load Demand Compatibility option, and more...
5	Fixes in the wiring diagrams.

Typeface: The typeface used in this document is *Arial*. Care must be taken not to mistake the upper-case letter I with the numeral 1. The numeral 1 has a top serif to avoid this confusion.

TABLE OF CONTENTS

Section	Page
1 INTRODUCTION.....	8
1.1 CLARIFICATION OF NOTATION.....	9
1.2 GLOSSARY OF TERMS.....	9
1.3 BIBLIOGRAPHY	11
1.3.1 INSTALLATION INSTRUCTIONS.....	11
1.3.2 MANUALS	12
1.3.3 TRAINING GUIDES	13
1.3.4 THIRD PARTY DOCUMENTS	13
2 SPECIFICATION.....	14
2.1 OPERATING TEMPERATURE.....	14
2.1.1 SCREEN HEATER OPERATION (WHEN FITTED)	14
2.2 REQUIREMENTS FOR UL	14
2.3 TERMINAL SPECIFICATION	15
2.4 POWER SUPPLY REQUIREMENTS.....	15
2.4.1 MODULE SUPPLY INSTRUMENTATION DISPLAY.....	15
2.5 VOLTAGE & FREQUENCY SENSING.....	16
2.6 CURRENT SENSING.....	16
2.6.1 VA RATING OF THE CTS.....	17
2.6.2 CT POLARITY	18
2.6.3 CT PHASING.....	18
2.6.4 CT CLASS.....	18
2.7 INPUTS.....	19
2.7.1 DIGITAL INPUTS	19
2.8 OUTPUTS.....	19
2.8.1 CONFIGURABLE VOLT-FREE RELAY OUTPUTS C & D.....	19
2.8.2 CONFIGURABLE DC OUTPUTS E, F, G, H, I & J	19
2.9 COMMUNICATION PORTS.....	20
2.10 COMMUNICATION PORT USAGE.....	21
2.10.1 USB SLAVE PORT (PC CONFIGURATION).....	21
2.10.2 USB HOST PORT (DATA LOGGING)	21
2.10.3 RS232 PORT.....	22
2.10.3.1 RECOMMENDED EXTERNAL MODEMS.....	22
2.10.3.2 RECOMMENDED PC RS232 SERIAL PORT ADD-ONS	23
2.10.3.3 RS232 USED FOR PLC COMMUNICATION	24
2.10.4 RS485 PORT.....	25
2.10.4.1 CABLE SPECIFICATION.....	25
2.10.4.2 RECOMMENDED PC RS485 SERIAL PORT ADD-ONS	26
2.10.4.3 RS485 USED FOR PLC COMMUNICATION	27
2.10.5 ETHERNET PORT	28
2.10.5.1 MODBUS TCP	28
2.10.5.2 ETHERNET PORT USED FOR PLC COMMUNICATION.....	28
2.10.5.3 SNMP.....	29
2.10.5.4 DIRECT PC CONNECTION.....	30
2.10.5.5 CONNECTION TO BASIC ETHERNET.....	31
2.10.5.6 CONNECTION TO COMPANY ETHERNET INFRASTRUCTURE	32
2.10.5.7 CONNECTION TO THE INTERNET	33
2.10.5.8 FIREWALL CONFIGURATION FOR INTERNET ACCESS	34
2.10.6 MSC (MULTI-SET COMMUNICATIONS) LINK	35
2.10.8 CAN PORT (REDUNDANT MSC).....	36
2.10.9 DSENET® (EXPANSION MODULES).....	38
2.11 SOUNDER	39
2.11.1 ADDING AN EXTERNAL SOUNDER	39
2.12 ACCUMULATED INSTRUMENTATION	39
2.13 DIMENSIONS AND MOUNTING.....	40
2.13.1 DIMENSIONS.....	40

2.13.2	PANEL CUTOUT.....	40
2.13.3	WEIGHT	40
2.13.4	FIXING CLIPS	41
2.13.5	CABLE TIE FIXING POINTS.....	42
2.13.6	SILICON SEALING GASKET	42
2.14	APPLICABLE STANDARDS	43
2.14.1	ENCLOSURE CLASSIFICATIONS	45
2.14.1.1	IP CLASSIFICATIONS.....	45
2.14.1.2	NEMA CLASSIFICATIONS.....	45
3	INSTALLATION.....	46
3.1	USER CONNECTIONS.....	46
3.2	CONNECTION DESCRIPTIONS	47
3.2.1	DC SUPPLY & DC OUTPUTS	47
3.2.2	CAN	48
3.2.3	MSC & DSENET®.....	49
3.2.4	OUTPUT C & D & V1 (MAINS) VOLTAGE & FREQUENCY SENSING.....	50
3.2.5	V2 (BUS) VOLTAGE & FREQUENCY SENSING.....	50
3.2.6	CURRENT TRANSFORMERS.....	51
3.2.6.1	MAINS CURRENT TRANSFORMERS	51
3.2.6.2	BUS/LOAD CURRENT TRANSFORMER	51
3.2.6.3	CT CONNECTIONS	52
3.2.7	DIGITAL INPUTS	52
3.2.8	RS485.....	53
3.2.9	RS232.....	54
3.2.10	USB SLAVE (PC CONFIGURATION) CONNECTOR	55
3.2.11	USB HOST (DATA LOGGING) CONNECTOR	55
3.3	TYPICAL WIRING DIAGRAM.....	56
3.3.1	3 PHASE, 4 WIRE WITH A BUS CT	57
3.3.2	EARTH SYSTEMS	58
3.3.2.1	NEGATIVE EARTH	58
3.3.2.2	POSITIVE EARTH	58
3.3.2.3	FLOATING EARTH	58
3.3.3	TYPICAL ARRANGEMENT OF DSENET®	59
3.3.4	TYPICAL ARRANGEMENT OF MSC LINK	60
3.4	ALTERNATE TOPOLOGY WIRING DIAGRAMS	61
3.4.1	SINGLE PHASE (L1 & N) 2 WIRE WITH A BUS CT	61
3.4.2	SINGLE PHASE (L1 & L2) 3 WIRE WITH A BUS CT	62
3.4.3	SINGLE PHASE (L1 & L3) 3 WIRE WITH A BUS CT	62
3.4.4	2 PHASE (L1 & L2) 3 WIRE WITH A BUS CT	63
3.4.5	2 PHASE (L1 & L3) 3 WIRE WITH A BUS CT	63
3.4.6	3 PHASE 3 WIRE DELTA WITH A BUS CT	64
3.4.7	3 PHASE, 4 WIRE WITH A BUS CT	65
3.4.8	3 PHASE, 4 WIRE WITH A LOAD CT.....	66
3.5	TYPICAL SINGLE LINE APPLICATION DRAWINGS	67
3.5.1	MULTI GENERATORS FOR PRIME POWER.....	67
3.5.2	MULTI GENERATORS FOR PRIME POWER USING LOAD-SHARE LINES	68
3.5.3	MULTI GENERATORS FOR PRIME POWER WITH BUS COUPLERS.....	69
3.5.4	MULTI GENERATORS WITH SINGLE SYNCHRONISING MAINS SWITCH	70
3.5.5	MULTI GENERATORS WITH SINGLE SYNCHRONISING TRANSFER SWITCH	71
3.5.6	MULTI GENERATORS WITH TWO SYNCHRONISING TRANSFER SWITCHES	72
3.5.7	MULTI GENERATORS & SYNCHRONISING TRANSFER SWITCHES.....	73
3.5.8	MULTI GENERATORS & TRANSFER SWITCHES WITH BUS COUPLER	74
3.5.9	SINGLE GENERATOR EXPORTING (BASE LOADING) POWER	75
3.5.10	MULTI GENERATORS EXPORTING (BASE LOADING) POWER	76
4	DESCRIPTION OF CONTROLS.....	77
4.1	CONTROL PUSH BUTTONS	79
4.2	VIEWING THE INSTRUMENT PAGES.....	83
4.2.1	STATUS	84
4.2.1.1	ELECTRICAL TRIP	84

4.2.1.2	WAITING FOR CONTROL.....	84
4.2.1.3	CONFIGURABLE STATUS SCREENS.....	85
4.2.2	MAINS.....	86
4.2.2.2	SYNCHROSCOPE OPERATION.....	87
4.2.3	BUS.....	88
4.2.3.1	COMMISSIONING SCREENS.....	89
4.2.3.2	DSE8X10 MSC CONNECTION STATUS.....	90
4.2.4	EXPANSION.....	91
4.2.5	CHARGER ID.....	92
4.2.6	ALARMS.....	93
4.2.7	EVENT LOG.....	94
4.2.8	COMMUNICATIONS.....	95
4.2.8.1	RS232 SERIAL PORT.....	95
4.2.8.2	RS485 SERIAL PORT.....	100
4.2.8.3	USB CONNECTION.....	102
4.2.8.4	ETHERNET.....	103
4.2.8.5	DSENET CONNECTION.....	104
4.2.8.6	MSC CONNECTION.....	104
4.2.9	SCHEDULE.....	105
4.2.10	EDITOR.....	105
4.2.11	PLC INSTRUMENTS.....	106
4.2.12	MISCELLANEOUS.....	108
4.2.12.1	DATA LOGGING.....	108
4.2.13	ABOUT.....	109
4.3	USER CONFIGURABLE INDICATORS.....	110
5	OPERATION.....	111
5.1	QUICKSTART GUIDE.....	111
5.1.1	STARTING THE GENERATOR(S).....	111
5.1.2	STOPPING THE GENERATOR(S).....	112
5.2	STOP/RESET MODE.....	113
5.3	MANUAL MODE.....	114
5.3.1	STARTING SEQUENCE.....	114
5.3.2	LOADING GENERATOR BUS.....	115
5.3.3	UNLOADING GENERATOR BUS.....	116
5.3.4	STOPPING SEQUENCE.....	116
5.4	TEST MODE.....	117
5.4.1	STARTING SEQUENCE.....	117
5.4.2	LOADING GENERATOR BUS.....	118
5.4.3	UNLOADING GENERATOR BUS.....	118
5.4.4	STOPPING SEQUENCE.....	118
5.5	AUTOMATIC MODE.....	119
5.5.1	WAITING IN AUTO MODE.....	119
5.5.2	STARTING SEQUENCE.....	119
5.5.3	LOADING GENERATOR BUS.....	120
5.5.4	UNLOADING GENERATOR BUS.....	120
5.5.5	STOPPING SEQUENCE.....	120
5.6	ISLAND OPERATION (LOAD SHARE).....	121
5.7	CONTINUOUS PARRALLEL OPERATION.....	123
5.7.1	BUS MODE (FIXED EXPORT / BASE LOAD).....	123
5.7.2	POWER MODES.....	125
5.7.2.1	FREQUENCY AND ACTIVE (KW) POWER MODES.....	125
5.7.2.2	VOLTAGE AND REACTIVE (KVAR) POWER CONTROL.....	126
5.7.2.3	SIMULATION INJECTION TESTING.....	127
5.7.3	MAINS MODE (PEAK LOPPING/SHAVING).....	128
5.8	MULTIPLE MAINS OPERATION.....	130
5.8.1	DSE8660 MKII PRIORITY.....	131
5.8.2	DSE8660 MKII BUS/LOAD CT.....	131
5.9	MANUAL BUS VOLTAGE & FREQUENCY CONTROL IN ISLAND MODE.....	132
5.10	SCHEDULER.....	133

5.10.1	STOP/RESET MODE	133
5.10.2	MANUAL MODE	133
5.10.3	TEST MODE	133
5.10.4	AUTO MODE	133
5.11	MSC COMPATIBILITY MODE	134
5.12	SMS CONTROL	135
5.13	DEAD BUS SYNCHRONISING (AUTO MODE)	136
5.13.1	BENEFIT OF SYSTEM	136
5.13.2	HARDWARE REQUIREMENTS	136
5.13.3	OPERATION	137
6	PROTECTIONS	138
6.1	ALARMS	138
6.2	INDICATIONS	139
6.3	WARNING ALARMS	140
6.4	ELECTRICAL TRIP ALARMS	145
6.5	MAINS DECOUPLING ALARMS	150
6.6	OUT OF SYNC MAINS	151
6.7	MAINS SEQUENCE ALARMS	152
6.8	FAULT RIDE THROUGH	153
7	FRONT PANEL CONFIGURATION	155
7.1	MAIN CONFIGURATION EDITOR	156
7.1.1	ACCESSING THE MAIN CONFIGURATION EDITOR	156
7.1.2	ENTERING PIN	156
7.1.3	EDITING A PARAMETER	157
7.1.4	EXITING THE MAIN CONFIGURATION EDITOR	157
7.1.5	ADJUSTABLE PARAMETERS	158
7.2	'RUNNING' CONFIGURATION EDITOR	160
7.2.1	ACCESSING THE 'RUNNING' CONFIGURATION EDITOR	160
7.2.2	ENTERING PIN	160
7.2.3	EDITING A PARAMETER	160
7.2.4	EXITING THE 'RUNNING' CONFIGURATION EDITOR	161
7.2.5	RUNNING EDITOR PARAMETERS	161
8	COMMISSIONING	162
8.1	BASIC CHECKS	162
8.2	DSE 4 STEPS TO SUCCESSFUL SYNCHRONISING	163
8.2.1	CONTROL (DSE8X10)	164
8.2.1.1	DETERMINING CONNECTIONS AND SETTINGS FOR GOVERNORS	164
8.2.1.2	DETERMINING CONNECTIONS AND SETTINGS FOR AVRS	166
8.2.2	METERING	168
8.2.2.1	CTS ON THE RIGHT PHASE	168
8.2.2.2	CTS IN THE RIGHT DIRECTION	168
8.2.3	COMMUNICATIONS	169
8.2.4	SYNC CHECKS	170
8.2.4.1	INCORRECTLY WIRED BREAKER	171
8.2.4.2	CORRECTLY WIRED BREAKER	172
9	FAULT FINDING	173
9.1	STARTING	173
9.2	INSTRUMENTS	174
9.3	LOADING	174
9.4	COMMUNICATIONS	175
9.5	SYNCHRONISING & LOAD SHARING	176
9.6	MISCELLANEOUS	176
10	MAINTENANCE, SPARES, REPAIR AND SERVICING	177
10.1	PURCHASING ADDITIONAL CONNECTOR PLUGS FROM DSE	177
10.1.1	PACK OF PLUGS	177
10.1.2	INDIVIDUAL PLUGS	177
10.2	PURCHASING ADDITIONAL FIXING CLIPS FROM DSE	178

10.3	PURCHASING ADDITIONAL SEALING GASKET FROM DSE	178
10.4	PURCHASING REAR MOUNT PANEL BRACKET FROM DSE	178
10.5	DSENET [®] EXPANSION MODULES	179
11	WARRANTY	180
12	DISPOSAL	180
12.1	WEEE (WASTE ELECTRICAL AND ELECTRONIC EQUIPMENT)	180

1 INTRODUCTION

This document details the installation and operation requirements of the DSE8660 MKII module and is part of the DSE Genset® range of products.

The manual forms part of the product and should be kept for the entire life of the product. If the product is passed or supplied to another party, ensure that this document is passed to them for reference purposes.

This is not a *controlled document*. DSE do not automatically inform on updates. Any future updates of this document are included on the DSE website at www.deepseaelectronics.com

The DSE86xx MKII series is designed to provide differing levels of functionality across a common platform. This allows the generator OEM greater flexibility in the choice of controller to use for a specific application.

The DSE8660 MKII module is designed to provide differing levels of functionality across a common platform. This allows the generator OEM greater flexibility in the choice of controller to use for a specific application.

Synchronising and Load Sharing features are included within the controller, along with the necessary protections for such a system.

The user also has the facility to view the system operating parameters via the text LCD display.

The DSE8660 MKII module has been designed to monitor the mains (utility) supply and automatically start/stop one or more generator sets equipped with DSE8610 MKII controllers depending upon the status of the mains (utility) supply.

The powerful ARM microprocessor contained within the module allows for incorporation of a range of complex features:

- *Text based LCD display*
- *True RMS Voltage*
- *Current and Power monitoring*
- *USB, RS232, RS485 and Ethernet Communications*
- *Fully configurable inputs for use as alarms or a range of different functions.*
- *Synchronising and load sharing with load demand start/stop*
- *Integral PLC to help provide customisation where required*
- *Data Logging*
- *R.O.C.O.F. and vector shift protection for detection of mains failure when in parallel with the mains.*



The DSE Configuration Suite PC Software allows alteration of selected operational sequences, timers, alarms and operational sequences. Additionally, the module's integral front panel configuration editor allows adjustment of this information.

Access to critical operational sequences and timers for use by qualified engineers, can be protected by a security code. Module access can also be protected by PIN code. Selected parameters can be changed from the module's front panel.

The module is housed in a robust plastic case suitable for panel mounting. Connections to the module are via locking plug and sockets.

1.1 CLARIFICATION OF NOTATION

Clarification of notation used within this publication.

 NOTE:	Highlights an essential element of a procedure to ensure correctness.
 CAUTION!	Indicates a procedure or practice, which, if not strictly observed, could result in damage or destruction of equipment.
 WARNING!	Indicates a procedure or practice, which could result in injury to personnel or loss of life if not followed correctly.

1.2 GLOSSARY OF TERMS

Term	Description
DSE8000 MKII, DSE8xxx MKII	All modules in the DSE8xxx MKII range.
DSE8600 MKII, DSE86xx MKII	All modules in the DSE86xx MKII range.
DSE8660 MKII	DSE8660 MKII module/controller
DSE8x10	DSE8610, DSE8610 MKII, DSE8710 and DSE8810 module/controller
DSE8x60	DSE8660, DSE8660 MKII, DSE8760 and DSE8860 module/controller
DSE8x80	DSE8680 module/controller
CAN	Controller Area Network Vehicle standard to allow digital devices to communicate to one another.
CDMA	Code Division Multiple Access. Cell phone access used in small number of areas including parts of the USA and Australia.
CT	Current Transformer An electrical device that takes a large AC current and scales it down by a fixed ratio to a smaller current.
BMS	Building Management System A digital/computer based control system for a building's infrastructure.
GSM	Global System for Mobile communications. Cell phone technology used in most of the World.
HMI	Human Machine Interface A device that provides a control and visualisation interface between a human and a process or machine.
IDMT	Inverse Definite Minimum Time
IEEE	Institute of Electrical and Electronics Engineers
LED	Light Emitting Diode
MSC	Multi-Set Communication
PLC	Programmable Logic Controller A programmable digital device used to create logic for a specific purpose.
R.O.C.O.F.	Rate Of Change Of Frequency
SCADA	Supervisory Control And Data Acquisition A system that operates with coded signals over communication channels to provide control and monitoring of remote equipment
SCR	Selective Catalytic Reduction A process that uses DEF with the aid of a catalyst to convert nitric oxide and nitrogen dioxide into nitrogen and water to reduce engine exhaust emission.

Continued over page...

Introduction

Term	Description
SIM	Subscriber Identity Module. The small card supplied by the GSM/CDMA provider that is inserted into the cell phone, GSM modem or DSEGateway device to give GSM/GPRS connection.
SMS	Short Message Service The text messaging service of mobile/cell phones.
SPN	Suspect Parameter Number A part of DTC that indicates what the failure is, e.g. oil pressure, coolant temperature, turbo pressure etc.

1.3 BIBLIOGRAPHY

This document refers to, and is referred by the following DSE publications which are obtained from the DSE website: www.deepseaelectronics.com or by contacting DSE technical support: support@deepseaelectronics.com.

1.3.1 INSTALLATION INSTRUCTIONS

Installation instructions are supplied with the product in the box and are intended as a 'quick start' guide only.

DSE Part	Description
053-032	DSE2548 LED Expansion Annunciator Installation Instructions
053-033	DSE2130 Input Expansion Installation Instructions
053-034	DSE2157 Output Expansion Installation Instructions
053-049	DSE9xxx Battery Charger Installation Instructions
053-125	DSE2131 Ratio-metric Input Expansion Installation Instructions
053-126	DSE2133 RTD/Thermocouple Input Expansion Installation Instructions
053-134	DSE2152 Ratio-metric Output Expansion Installation Instructions
053-147	DSE9460 & DSE9461 Battery Charger Installation Instructions
053-182	DSE8610 MKII Installation Instructions
053-184	DSE8660 MKII Installation Instructions
053-185	DSE9473 & DSE9483 Battery Charger Installation Instructions
053-248	DSE8920 Installation Instructions

1.3.2 MANUALS

Product manuals are obtained from the DSE website: www.deepseaelectronics.com or by contacting DSE technical support: support@deepseaelectronics.com.

DSE Part	Description
N/A	DSEGencomm (MODBUS protocol for DSE controllers)
057-045	Guide to Synchronising and Load Sharing Part 1 (Usage of DSE Load Share Controllers in synchronisation / load sharing systems.)
057-046	Guide to Synchronising and Load Sharing Part 2 (Governor & AVR Interfacing)
057-047	Load Share System Design and Commissioning Guide
057-082	DSE2130 Input Expansion Operator Manual
057-083	DSE2157 Output Expansion Operator Manual
057-084	DSE2548 Annunciator Expansion Operator Manual
057-085	DSE9xxx Battery Charger Operator Manual
057-139	DSE2131 Ratio-metric Input Expansion Manual
057-140	DSE2133 RTD/Thermocouple Expansion Manual
057-141	DSE2152 Ratio-metric Output Expansion Manual
057-151	DSE Configuration Suite PC Software Installation & Operation Manual
057-175	PLC Programming Guide For DSE Controllers
057-176	DSE9460 & DSE9461 Battery Charger Operator Manual
057-220	Options for Communications with DSE Controllers
057-238	DSE8610 MKII Configuration Suite PC Software Manual
057-254	DSE8610 MKII Operator Manual
057-257	DSE8660 MKII Configuration Suite PC Software Manual
057-239	DSE8620 MKII Software Manual
057-301	DSE8620 MKII Operators Manual
057-303	DSE8920 Software Manual
057-305	DSE8910 Software Manual
057-310	DSE8910 Operators Manual
057-311	DSE8920 Operators Manual
057-312	DSEAssistant PC Software Manual
057-314	Advanced PLC Programming Guide for DSE Controllers

1.3.3 TRAINING GUIDES

Training guides are provided as 'hand-out' sheets on specific subjects during training sessions and contain specific information regarding to that subject.

DSE Part	Description
056-001	Four Steps To Synchronising
056-005	Using CTs With DSE Products
056-006	Introduction to Comms
056-007	Advantages of Bus/Load CT
056-010	Over Current Protection
056-011	MSC Link
056-013	Load Demand Scheme
056-021	Mains Decoupling
056-022	Breaker Control
056-024	GSM Modem
056-026	kW, kvar, kVA and pf.
056-030	Module PIN Codes
056-033	Synchronising Requirements
056-036	Expansion Modules
056-042	Bus Mode or Mains Mode
056-043	Sync Process
056-045	PLC as Load Demand Controller
056-047	Out of Sync and Failed To Close
056-051	Sending DSEGencomm Control Keys
056-053	Recommended Modems
056-069	Firmware Update
056-072	Dead Bus Synchronising
056-075	Adding Language Files
056-076	Reading DSEGencomm Alarms
056-079	Reading DSEGencomm Status
056-080	MODBUS
056-081	Screen Heaters
056-082	Override Gencomm PLC Example
056-083	Synchronising & Loadsharing
056-086	G59
056-089	DSE86xx MKI to DSE86xx MKII Conversion
056-091	Equipotential Earth Bonding
056-092	Best Practices for Wiring Restive Sensors
056-094	MSC Compatibility
056-095	Remote Start Input Functions
056-097	USB Earth Loop and Isolation
056-099	Digital Output to Digital Input Connection

1.3.4 THIRD PARTY DOCUMENTS

The following third party documents are also referred to:

Reference	Description
ISBN 1-55937-879-4	IEEE Std C37.2-1996 IEEE Standard Electrical Power System Device Function Numbers and Contact Designations. Institute of Electrical and Electronics Engineers Inc
ISBN 0-7506-1147-2	Diesel generator handbook. L.L.J. Mahon
ISBN 0-9625949-3-8	On-Site Power Generation. EGSA Education Committee.

2 SPECIFICATION

2.1 OPERATING TEMPERATURE

Module	Specification
DSE86xx MKII	-30 °C +70 °C (-22 °F +158 °F)
Display Heater Variants	-40 °C +70 °C (-40 °F +158 °F)

2.1.1 SCREEN HEATER OPERATION (WHEN FITTED)

Screen Heater Function	Specification
Turn On When Temperature Falls Below	-10 °C (+14 °F)
Turn Off When Temperature Rises Above	-5 °C (+23 °F)

2.2 REQUIREMENTS FOR UL

	<p>WARNING! More than one live circuit exists, refer to section entitled <i>Typical Wiring Diagram</i> elsewhere in this document</p>
---	--

Specification	Description
Screw Terminal Tightening Torque	4.5 lb-in (0.5 Nm)
Conductors	<p>Terminals suitable for connection of conductor size 13 AWG to 20 AWG (0.5 mm² to 2.5 mm²).</p> <p>Conductor protection must be provided in accordance with NFPA 70, Article 240</p> <p>Low voltage circuits (35 V or less) must be supplied from the engine starting battery or an isolated secondary circuit.</p> <p>The communication, sensor, and/or battery derived circuit conductors shall be separated and secured to maintain at least ¼" (6 mm) separation from the generator and mains connected circuit conductors unless all conductors are rated 600 V or greater.</p>
Current Inputs	Must be connected through UL Listed or Recognized isolating current transformers with the secondary rating of 5 A max.
Communication Circuits	Must be connected to communication circuits of UL Listed equipment
DC Output Pilot Duty	0.5 A
Mounting	<p>Suitable for flat surface mounting in Type 1 Enclosure Type rating with surrounding air temperature -22 °F to +122 °F (-30 °C to +50 °C)</p> <p>Suitable for pollution degree 3 environments when voltage sensing inputs do not exceed 300 V. When used to monitor voltages over 300 V device to be installed in an unventilated or filtered ventilation enclosure to maintain a pollution degree 2 environment.</p>
Operating Temperature	-22 °F to +122 °F (-30 °C to +50 °C)

2.3 TERMINAL SPECIFICATION

Description	Specification	
Connection Type	Two part connector. Male part fitted to module Female part supplied in module packing case - Screw terminal, rising clamp, no internal spring.	 <p>Example showing cable entry and screw terminals of a 10 way connector</p>
Minimum Cable Size	0.5 mm ² (AWG 24)	
Maximum Cable Size	2.5 mm ² (AWG 12)	
Tightening Torque	0.5 Nm (4.5 lb-in)	
Wire Strip Length	7 mm (9/32")	

2.4 POWER SUPPLY REQUIREMENTS

Description	Specification
Minimum Supply Voltage	5 V continuous
Cranking Dropouts	Able to survive 0 V for 100 ms providing the supply was at least was greater than 5 V for 2 seconds before the dropout and recovers to 5 V afterwards.
Maximum Supply Voltage	35 V continuous (60 V protection)
Reverse Polarity Protection	-35 V continuous
Maximum Operating Current	530 mA at 12 V 280 mA at 24 V
Maximum Standby Current	320 mA at 12 V 120 mA at 24 V
Maximum Current When In Sleep Mode	140 mA at 12 V 75 mA at 24 V
Typical Power (Controller On, Heater Off)	3.8 W to 4.1 W
Typical Power (Controller On, Heater On)	6.8 W to 7.1 W

2.4.1 MODULE SUPPLY INSTRUMENTATION DISPLAY

Description	Specification
Range	0 V to 70 V DC (Maximum continuous operating voltage of 35 V DC)
Resolution	0.1 V
Accuracy	1 % full scale (± 0.35 V)

2.5 VOLTAGE & FREQUENCY SENSING

Description	Specification
Measurement Type	True RMS conversion
Sample Rate	40 kHz
Harmonics	Up to 21 st or better
Input Impedance	300 k Ω phase to neutral
Phase To Neutral	15 V (minimum required for sensing frequency) to 415 V AC (absolute maximum) Suitable for 345 V AC nominal (± 20 % for under/overvoltage detection)
Phase To Phase	25 V (minimum required for sensing frequency) to 720 V AC (absolute maximum) Suitable for 600 V AC nominal (± 20 % for under/overvoltage detection)
Common Mode Offset From Earth	100 V AC (max)
Resolution	1 V AC phase to neutral 2 V AC phase to phase
Accuracy	± 1 % of full scale phase to neutral ± 1 % of full scale phase to phase
Minimum Frequency	3.5 Hz
Maximum Frequency	75.0 Hz
Frequency Resolution	0.1 Hz
Frequency Accuracy	± 0.05 Hz

2.6 CURRENT SENSING

Description	Specification
Measurement Type	True RMS conversion
Sample Rate	40 kHz
Harmonics	Up to 21 st or better
Nominal CT Secondary Rating	1 A and 5 A
Maximum Continuous Current	5 A
Overload Measurement	15 A
Absolute Maximum Overload	50 A for 0.2 second 30 A for 5 second
Burden	0.5 VA (0.02 Ω current shunts)
Common Mode Offset	70 V peak plant ground to CT common terminal under fault condition
Resolution	25 mA
Accuracy	± 1 % of Nominal (excluding CT error)

2.6.1 VA RATING OF THE CTS

NOTE: Details for 4 mm² cables are shown for reference only. The connectors on the DSE modules are only suitable for cables up to 2.5 mm².

The VA burden of the module on the CTs is 0.5 VA. However depending upon the type and length of cabling between the CTs and the module, CTs with a greater VA rating than the module are required.

The distance between the CTs and the measuring module should be estimated and cross-referenced against the chart opposite to find the VA burden of the cable itself.

If the CTs are fitted within the alternator top box, the star point (common) of the CTs should be connected to system ground (earth) as close as possible to the CTs. This minimises the length of cable used to connect the CTs to the DSE module.

Example:

If 1.5 mm² cable is used and the distance from the CT to the measuring module is 20 m, then the burden of the cable alone is approximately 15 VA. As the burden of the DSE controller is .5 VA, then a CT with a rating of at least 15 VA + 0.5 VA = 15.5 VA must

be used. If 2.5 mm² cables are used over the same distance of 20 m, then the burden of the cable on the CT is approximately 7 VA. CT's required in this instance is at least 7.5 VA (7 + 0.5).

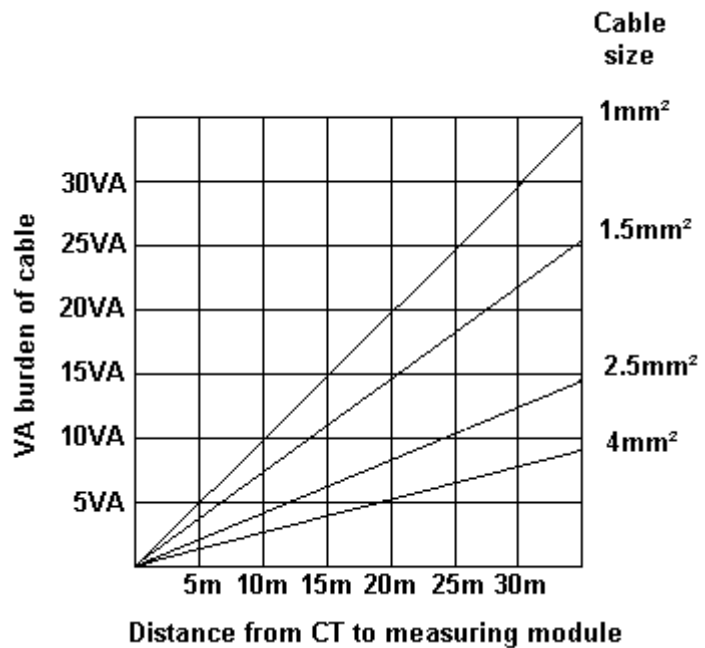

2.6.2 CT POLARITY

NOTE: Take care to ensure correct polarity of the CT primary as shown above. If in doubt, check with the CT supplier.

Take care to ensure the correct polarity of the CTs. Incorrect CT orientation leads to negative kW readings when the set is supplying power. Take note that paper stick-on labels on CTs that show the orientation are often incorrectly placed on the CT. It is more reliable to use the labelling in the case moulding as an indicator to orientation (if available).

To test orientation, run the generator in island mode (not in parallel with any other supply) and load the generator to around 10 % of the set rating. Ensure the DSE module shows positive kW for all three individual phase readings.

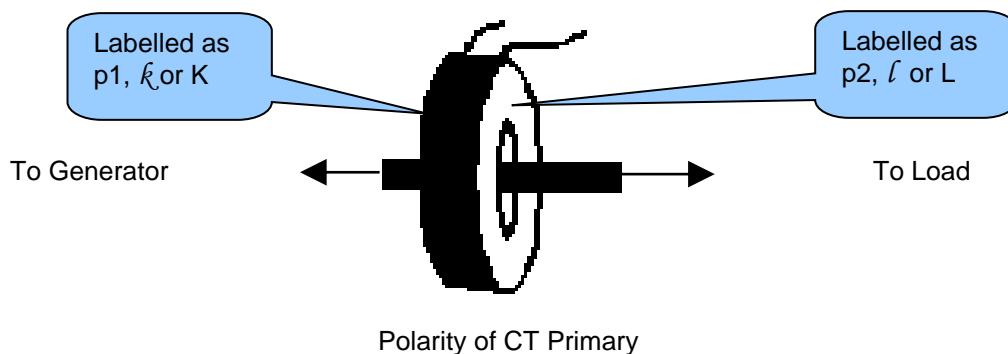

2.6.3 CT PHASING

Take particular care that the CTs are connected to the correct phases. For instance, ensure that the CT on phase 1 is connected to the terminal on the DSE module intended for connection to the CT for phase 1.

Additionally ensure that the voltage sensing for phase 1 is actually connected to generator phase 1. Incorrect connection of the phases as described above results in incorrect power factor (pf) measurements, which in turn results in incorrect kW measurements.

One way to check for this is to make use of a single-phase load. Place the load on each phase in turn, run the generator and ensure the kW value appears in the correct phase. For instance if the load is connected to phase 3, ensure the kW figure appears in phase 3 display and not in the display for phase 1 or 2.

2.6.4 CT CLASS

Ensure the correct CT type is chosen. For instance if the DSE module is providing over current protection, ensure the CT is capable of measuring the overload level required to protect against, and at the accuracy level required.

For instance, this may mean fitting a protection class CT (P15 type) to maintain high accuracy while the CT is measuring overload currents.

Conversely, if the DSE module is using the CT for instrumentation only (current protection is disabled or not fitted to the controller), then measurement class CTs can be used. Again, bear in mind the accuracy required. The DSE module is accurate to better than 1% of the full-scale current reading. To maintain this accuracy, fit a Class 0.5 or Class 1 CT.

Check with the CT manufacturer for further advice on selecting CTs.

2.7 INPUTS

2.7.1 DIGITAL INPUTS

Description	Specification
Number	12 configurable digital inputs (16 when <i>Analogue Inputs</i> are configured as digital inputs)
Arrangement	Contact between terminal and ground
Low Level Threshold	2.1 V minimum
High Level Threshold	6.6 V maximum
Maximum Input Voltage	+50 V DC with respect to plant supply negative
Minimum Input Voltage	-24 V DC with respect to plant supply negative
Contact Wetting Current	7 mA typical
Open Circuit Voltage	12 V typical

2.8 OUTPUTS

2.8.1 CONFIGURABLE VOLT-FREE RELAY OUTPUTS C & D

Description	Specification
Type	Normally used for load switching control Fully configurable volt-free relays. Output C normally closed and Output D normal open.
Rating	8 A resistive at 250 V AC

2.8.2 CONFIGURABLE DC OUTPUTS E, F, G, H, I & J

Description	Specification
Type	Fully configurable, supplied from DC supply terminal 2.
Rating	2 A resistive at module supply.

2.9 COMMUNICATION PORTS

 **NOTE: All communication ports can be used at the same time.**

Description	Specification
USB Slave Port	Type B USB 2.0 For connection to PC running DSE Configuration Suite Max distance 5 m (16 feet)
USB Host Port	Type A USB 2.0 Capability to add a maximum of 16 GB USB storage device for data recording only
RS232 Serial Port	Non – isolated Max Baud rate 115 k baud subject to configuration TX, RX, RTS, CTS, DSR, DTR, DCD Male 9 way D type connector Max distance 15 m (50 feet)
2 x RS485 Serial Ports	Isolated Data connection 2 wire + common Half Duplex Data direction control for Transmit (by s/w protocol) Max Baud Rate 115.2 kbaud subject to configuration External termination required (120 Ω) Max common mode offset 70 V (on board protection transorb) Max distance 1.2 km (¾ mile)
Ethernet	Auto detecting 10/100 Mbit Ethernet port.
MSC (Multi Set Communication) and CAN Port	 NOTE: For additional length, the DSE124 CAN & MSC Extender is available. For more information, refer to DSE Publication: 057-116 DSE124 Operator Manual
	Standard implementation of 'Slow mode', up to 250 kbits/s Data connection 2 wire + common Isolated External termination required (120 Ω) Max common mode offset 70 V (on board protection transorb) Max distance 250 m using Belden 9841 Cable or equivalent
DSENet® (Expansion Comms) Port	Non-isolated Data connection 2 wire + common Half Duplex Data direction control for Transmit (by s/w protocol) Baud Rate of 115 kbaud Internal termination fitted (120 Ω) Max common mode offset ±5 V Max distance 1.2 km (¾ mile)

2.10 COMMUNICATION PORT USAGE

2.10.1 USB SLAVE PORT (PC CONFIGURATION)

NOTE: DSE stock 2 m (6.5 feet) USB type A to type B cable, DSE Part Number: 016-125. Alternatively they are purchased from any PC or IT store.

NOTE: The DC supply must be connected to the module for configuration by PC.

NOTE: For further details of module configuration, refer to DSE Publication: 057-257 *DSE8660 MKII Configuration Suite PC Software Manual*.

The USB port is provided to give a simple means of connection between a PC and the controller. Using the DSE Configuration Suite Software, the operator is then able to control the module, starting or stopping the engine, selecting operating modes, etc.

Additionally, the various operating parameters (such as coolant temperature, oil pressure, etc.) of the engine are available to be viewed or changed.

To connect a module to a PC by USB, the following items are required:

DSE86xx MKII Controller



DSE Configuration Suite PC Software
(Available from www.deepseaelectronics.com).

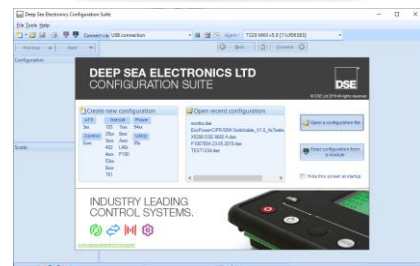

USB cable Type A to Type B.
(This is the same cable as often used between a PC and a USB printer)

DSE can supply this cable if required:
PC Configuration interface lead (USB type A – type B) DSE Part No 016-125



2.10.2 USB HOST PORT (DATA LOGGING)

USB Type A connection for an external USB storage device of maximum 16 GB for instrumentation data logging. A 16 GB external USB storage device allows for 33 weeks, 4 days and 20 minutes worth of data, assuming 20 parameters were configured to be logged, each with a *Log Interval* of 1 second.

2.10.3 RS232 PORT

NOTE: For direct connection an RS232 null modem (crossover) cable is required. This is rated to a maximum cable length of 15 m.

NOTE: For a single module to PC connection and distances up to 5 m (16 feet) the USB connection method is more suitable and provides for a lower cost alternative to RS485 (which is more suited to longer distance connections).

The RS232 port on the controller supports the MODBUS RTU protocol and is for connection to a single MODBUS master device only.

The MODBUS register table for the controller is available upon request from the DSE Technical Support Department.

RS232 is for short distance communication (max 15m) and is typically used to connect the controller to a telephone or GSM modem for more remote communications.

The various operating parameters (such as coolant temperature, oil pressure, etc.) of the remote engine are viewed or changed.

Many PCs are not fitted with an internal RS232 serial port. DSE DOES NOT recommend the use of USB to RS232 converters but can recommend PC add-ons to provide the computer with an RS232 port.

2.10.3.1 RECOMMENDED EXTERNAL MODEMS

NOTE: Connecting a modem directly to the module's RS232 is for legacy support only. When a new installation requires remote communication using the cellular network, refer to DSE products DSE890 MKII, DSE891 and DSEWebNet on the DSE website: www.deepseaelectronics.com.

NOTE: For GSM modems a SIM card is required, supplied by the GSM network provider:

For SMS only, a 'normal' voice SIM card is required. This enables the controller to send SMS messages to designated mobile phones upon status and alarm conditions.

For a data connection to a PC running DSE Configuration Suite Software, a 'special' CSD (Circuit Switched Data) SIM card is required that enables the modem to answer an incoming data call. Many 'pay as you go' services do not provide a CSD (Circuit Switched Data) SIM card.

Multitech Global Modem – MultiModem ZBA (PSTN)



Sierra Fastrak Xtend GSM modem kit (PSU, Antenna and modem)*



2.10.3.2 RECOMMENDED PC RS232 SERIAL PORT ADD-ONS

NOTE: DSE have no business tie to Brainboxes. Over many years, our own engineers have used these products and are happy to recommend them.

NOTE: For further details of setting up the devices below, refer to the manufacture whose details are below.

Remember to check these parts are suitable for your PC. Consult your PC supplier for further advice.

Brainboxes PM143 PCMCIA RS232 card (for laptop PCs)



Brainboxes VX-001 Express Card RS232 (for laptops and nettops PCs)



Brainboxes UC246 PCI RS232 card (for desktop PCs)



Brainboxes PX-246 PCI Express 1 Port RS232 1 x 9 Pin (for desktop PCs)



Supplier:
Brainboxes
Tel: +44 (0)151 220 2500
Web: <http://www.brainboxes.com>
Email: Sales: sales@brainboxes.com

2.10.3.3 RS232 USED FOR PLC COMMUNICATION

NOTE: When the *RS232 Port Usage* is selected to “*PLC Comms*” it becomes the Master RS232 module, the other module’s *Port Usage* must be configured to “*Gencomm*”. This allows the “*PLC Comms*” configured module to read from the “*Gencomm*” configured module. For details on how to configure the *PLC Editor* to read through its RS232, refer to DSE Publication: *057-314 Advanced PLC Software Manual* which is found on our website: www.deepseaelectronics.com

The DSE module is able to communicate with another DSE module using its RS232 when its *Port Usage* is configured to *PLC Comms*. This allows the DSE module to read from another module by RS232. This is controlled from the PLC by defining the specific GenComm registers to read then the values read are used inside the PLC to perform certain tasks.

The other module must have its RS232 Port Usage set to *Gencomm* to act as a slave and be able to respond to the ‘Master’ (configured to *PLC Comms*). This is because there cannot be two ‘Masters’ on the same RS232 network.

All the DSE modules must have the same *Baud Rate*, but different *Slave ID*.

Example of configuring the RS232 Port for PLC Comms using the DSE Configuration Suite Software:

Serial Port Configuration	
Slave ID	10
Baud Rate	115200
Port Usage	PLC Comms

2.10.4 RS485 PORT

NOTE: For a single module to PC connection and distances up to 5 m (16 feet) the USB connection method is more suitable and provides for a lower cost alternative to RS485 (which is more suited to longer distance connections).

The RS485 port on the controller supports the MODBUS RTU protocol and is for connection to a single MODBUS master device only.

The DSE MODBUS register table for the controller is available upon request from the DSE Technical Support Department.

RS485 is used for point-to-point cable connection of more than one device (maximum 32 devices) and allows for connection to PCs, PLCs and Building Management Systems (to name just a few devices).

One advantage of the RS485 interface is the large distance specification (1.2 km when using Belden 9841 (or equivalent) cable. This allows for a large distance between the module and a PC running the DSE Configuration Suite software. The operator is then able to control the module, starting or stopping the engine, selecting operating modes, etc.

The various operating parameters (such as coolant temperature, oil pressure, etc.) of the remote engine are viewed or changed.

Many PCs are not fitted with an internal RS485 serial port. DSE DOES NOT recommend the use of USB to RS485 converters but can recommend PC add-ons to provide the computer with an RS485port.

2.10.4.1 CABLE SPECIFICATION

NOTE: DSE recommend Belden 9841 (or equivalent) cable for RS485 communication. This is rated to a maximum cable length of 1.2 km. DSE Stock Belden 9841 cable, DSE Part Number: 016-030.

Description	Specification
Cable Type	Two core screened and shielded twisted pair
Cable Characteristics	120 Ω impedance Low capacitance
Recommended Cable	Belden 9841 Belden 9271
Maximum Cable Length	1200 m ($\frac{3}{4}$ mile) when using Belden 9841 or direct equivalent. 600 m (656 yards) when using Belden 9271 or direct equivalent.
RS485 Topology	"Daisy Chain" Bus with no stubs (spurs)
RS485 Termination	120 Ω . Not fitted internally to module. Must be fitted externally to the 'first' and 'last' device on the RS485 link.

2.10.4.2 RECOMMENDED PC RS485 SERIAL PORT ADD-ONS

NOTE: DSE have no business tie to Brainboxes. Over many years, our own engineers have used these products and are happy to recommend them.

NOTE: For further details of setting up the devices below, refer to the manufacture whose details are below.

Remember to check these parts are suitable for your PC. Consult your PC supplier for further advice.

Brainboxes PM154 PCMCIA RS485 card (for laptops PCs)
Set to 'Half Duplex, Autogating" with 'CTS True' set to 'enabled'



Brainboxes VX-023 ExpressCard 1 Port RS422/485 (for laptops and nettop PCs)



Brainboxes UC320 PCI Velocity RS485 card (for desktop PCs)
Set to 'Half Duplex, Autogating" with 'CTS True' set to 'enabled'



Brainboxes PX-324 PCI Express 1 Port RS422/485 (for desktop PCs)



Supplier:
Brainboxes
Tel: +44 (0)151 220 2500
Web: <http://www.brainboxes.com>
Email: Sales: sales@brainboxes.com

2.10.4.3 RS485 USED FOR PLC COMMUNICATION

NOTE: When the *RS485 Port Usage* is selected to “*PLC Comms*” the module becomes the Master RS485, all other modules’ *Port Usage* must be configured to “*Gencomm*”. This allows the “*PLC Comms*” configured module read from the “*Gencomm*” configured module(s). For details on how to configure the *PLC Editor* to read through its RS485, refer to DSE Publication: *057-314 Advanced PLC Software Manual* which is found on our website: www.deepseaelectronics.com

The DSE module is able to communicate with other DSE modules using its RS485 when its *Port Usage* is configured to *PLC Comms*. This allows the DSE module to read from other modules by RS485. This is controlled from the PLC by defining the specific GenComm registers to read then the vales read are used inside the PLC to perform certain tasks.

The other modules must all have their RS485 Port Usage set to *Gencomm* to act as a slave and be able to respond to the ‘Master’ (configured to *PLC Comms*). This is because there cannot be two ‘Masters’ over the same RS485 network.

All the DSE modules must have the same *Baud Rate*, but different *Slave ID*.

Example of configuring the RS485 Port for PLC Comms using the DSE Configuration Suite Software:

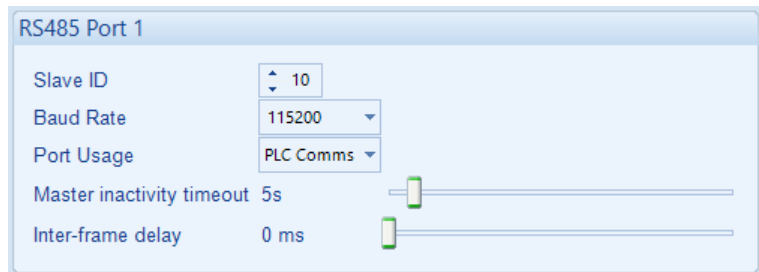

2.10.5 ETHERNET PORT

 **NOTE:** For further details of module configuration, refer to DSE Publication: *057-257 DSE8660 MKII Configuration Suite Software Manual*.

 **NOTE:** For a single module to PC connection and distances up to 5 m (16 feet) the USB connection method is more suitable and provides for a lower cost alternative to Ethernet (which is more suited to longer distance connections).

 **NOTE:** DSE stock 2 m (6.5 feet) Ethernet Cable, DSE Part Number: 016-137. Alternatively they can be purchased from any PC or IT store.

Ethernet is used for point-to-point cable connection of more than one device and allows for connection to PCs, PLCs, Building Management Systems and SNMP Managers (to name just a few devices) or to other DSE modules using the *PLC Editor*.

One advantage of the Ethernet interface is the ability to interface into an existing LAN (Local Area Network) connection for remote connection via an internet connection. This allows for a large distance between the module and a PC running the DSE Configuration Suite software or any external device. The operator is then able to control the module, starting or stopping the engine, selecting operating modes, etc through various different means.

2.10.5.1 MODBUS TCP

The Ethernet port on the controller supports the Modbus TCP protocol and is for connection for up to five Modbus master devices. The various operating parameters (such as coolant temperature, oil pressure, etc.) of the remote engine are viewed or changed.

The DSE MODBUS register table for the controller is available upon request from the DSE Technical Support Department.

2.10.5.2 ETHERNET PORT USED FOR PLC COMMUNICATION

 **NOTE:** For details on how to configure the *PLC Editor* to read through the TCP/IP, refer to DSE Publication: *057-314 Advanced PLC Software Manual* which is found on our website: www.deepseaelectronics.com

The DSE module is able to communicate with other DSE modules using the Ethernet Port, this is configured from the *PLC Editor* to allow it read specific GenComm registers from other modules over the TCP/IP to perform certain tasks in the PLC.

When the DSE module is configured to communicate with the other modules via the TCP/IP it becomes a MODBUS TCP Master, hence care must be taken on the slave TCP modules not to exceed their total supported five MODBUS TCP masters.

2.10.5.3 SNMP

NOTE: For further details of module configuration, refer to DSE Publication: *057-257 DSE8660 MKII Configuration Suite Software Manual.*

The Ethernet port on the controller supports V2c of the Simple Network Management Protocol (SNMP) and is able to connect to two SNMP managers. SNMP is an international standard protocol for managing devices on IP networks. It is used to monitor network-attached devices for conditions that warrant administrative attention.

Up to two administrative computers (SNMP managers) monitor the DSE module. Should an 'event' occur, the DSE module reports information via SNMP TRAP messages to the SNMP manager. The SNMP TRAP messages that are sent are configured used the DSE Configuration Suite PC Software by the system integrator. An example of the available SNMP TRAP messages is shown below.

Notifications	
	SNMP Trap
Named Alarms	<input checked="" type="checkbox"/>
Unnamed Alarms	<input checked="" type="checkbox"/>
Mode Change	<input checked="" type="checkbox"/>
Power Up	<input checked="" type="checkbox"/>
Mains Fail	<input checked="" type="checkbox"/>
Mains Return	<input checked="" type="checkbox"/>
Bus Off Load	<input checked="" type="checkbox"/>
Bus On Load	<input checked="" type="checkbox"/>

Additionally, the DSE module responds to GET / SET messages from the SNMP manager to allow the operating mode of the DSE module to be changed, or instrumentation values to be retrieved. The SNMP manager knows how to communicate to the DSE module by using the .MIB file provided by DSE.

Many third party SNMP managers exist. DSE do not produce or supply SNMP managers.

The DSE MIB file for the controller is available upon request from the DSE Technical Support Department or by downloading it from the DSE website, www.deepseaelectronics.com.

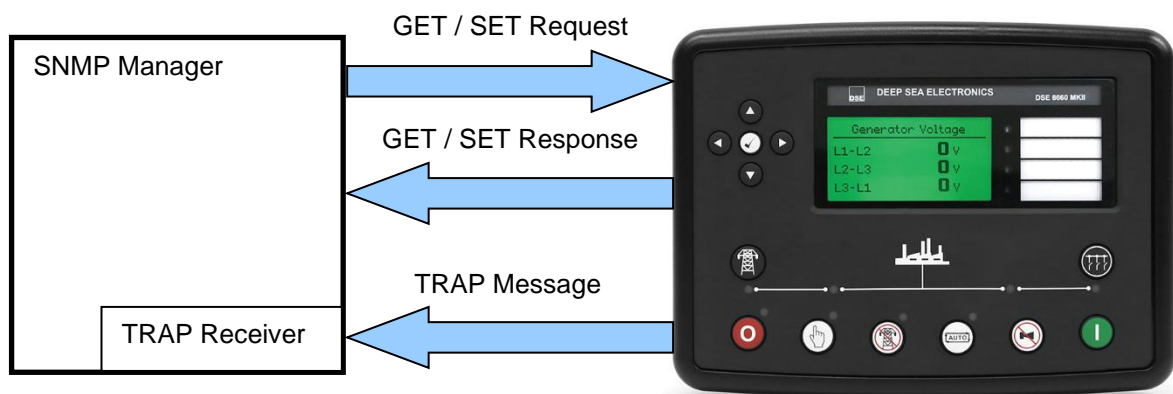

2.10.5.4 DIRECT PC CONNECTION





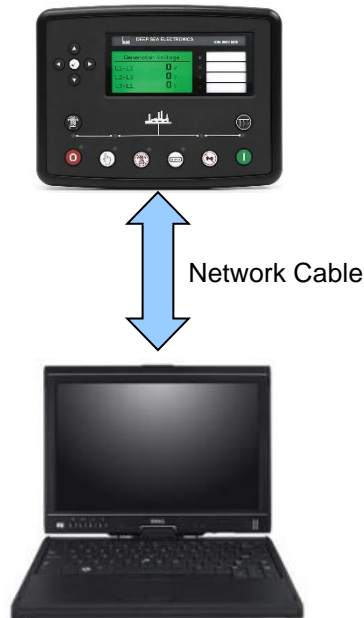





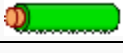
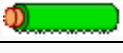

Requirements

- Ethernet cable (see below)
- PC with Ethernet port

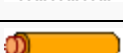
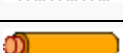

Ethernet Cable Wiring Detail

NOTE: DSE stock 2 m (6.5 feet) Ethernet Cable, DSE Part Number: 016-137. Alternatively they can be purchased from any PC or IT store.

Pin	Connection 1 (T568A)	Connection 2 (T568A)
1	 white/green stripe	 white/green stripe
2	 green solid	 green solid
3	 white/orange stripe	 white/orange stripe
4	 blue solid	 blue solid
5	 white/blue stripe	 white/blue stripe
6	 orange solid	 orange solid
7	 white/brown stripe	 white/brown stripe
8	 brown solid	 brown solid

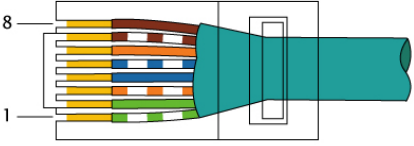

EIA/TIA-568A

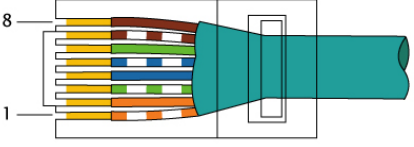

EIA/TIA-568B

2.10.5.5 CONNECTION TO BASIC ETHERNET





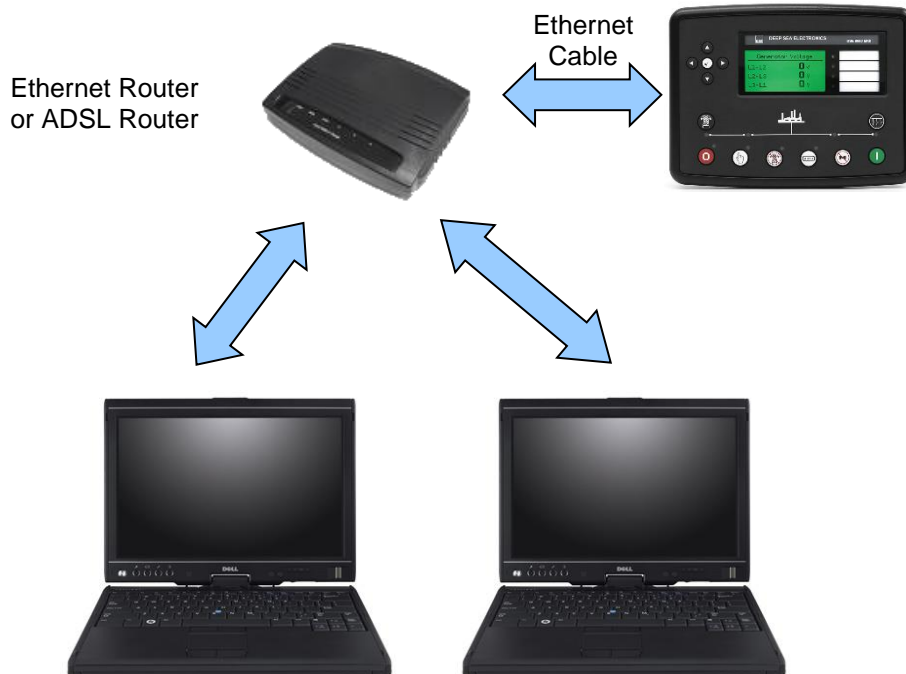







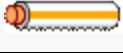

Requirements

- Ethernet cable (see below)
- Working Ethernet (company or home network)
- PC with Ethernet port

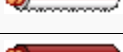
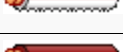

Ethernet Cable Wiring Detail

NOTE: DSE stock 2 m (6.5 feet) Ethernet Cable, DSE Part Number: 016-137. Alternatively they can be purchased from any PC or IT store.

Pin	Connection 1 (T568A)	Connection 2 (T568A)
1	 white/green stripe	 white/green stripe
2	 green solid	 green solid
3	 white/orange stripe	 white/orange stripe
4	 blue solid	 blue solid
5	 white/blue stripe	 white/blue stripe
6	 orange solid	 orange solid
7	 white/brown stripe	 white/brown stripe
8	 brown solid	 brown solid

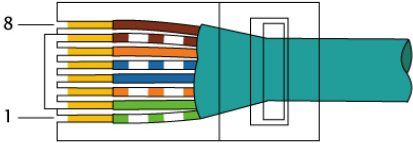

EIA/TIA-568A

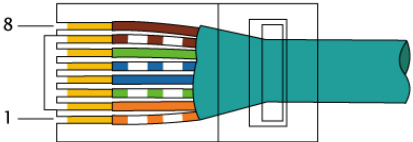

EIA/TIA-568B

2.10.5.6 CONNECTION TO COMPANY ETHERNET INFRASTRUCTURE





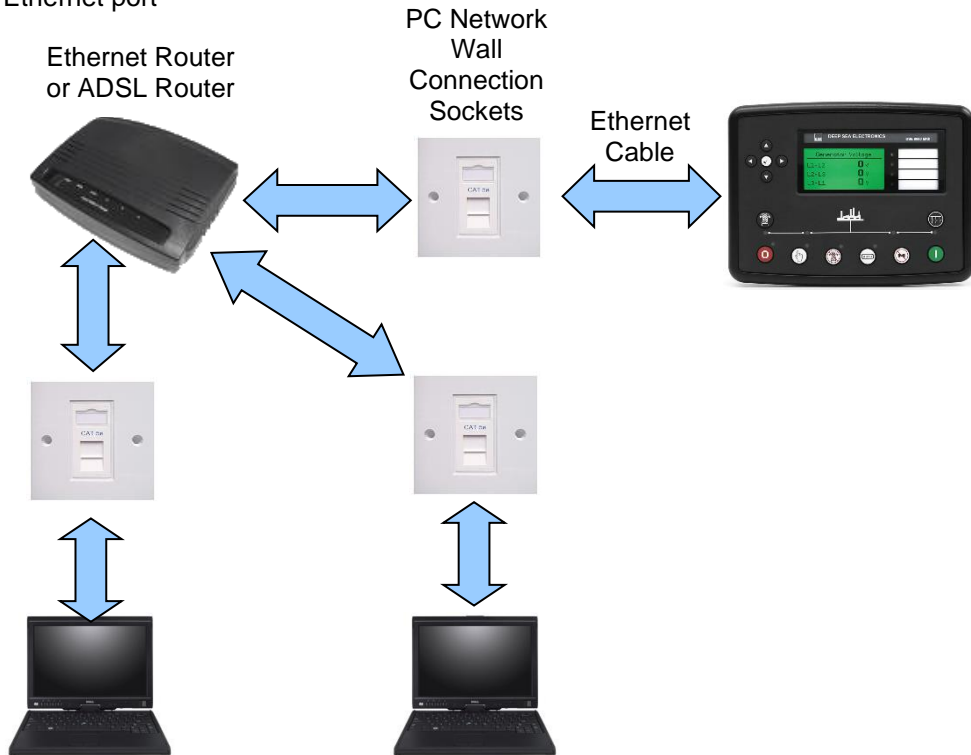











Requirements

- DSE module with the ability to connect to Ethernet
- Ethernet cable (see below)
- Working Ethernet (company or home network)
- PC with Ethernet port



Ethernet Cable Wiring Detail

NOTE: DSE stock 2 m (6.5 feet) Ethernet Cable, DSE Part Number: 016-137. Alternatively they can be purchased from any PC or IT store.

Pin	Connection 1 (T568A)	Connection 2 (T568A)
1	 white/green stripe	 white/green stripe
2	 green solid	 green solid
3	 white/orange stripe	 white/orange stripe
4	 blue solid	 blue solid
5	 white/blue stripe	 white/blue stripe
6	 orange solid	 orange solid
7	 white/brown stripe	 white/brown stripe
8	 brown solid	 brown solid

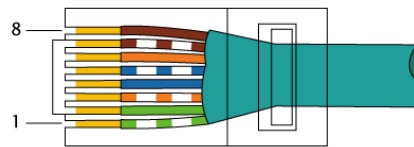

EIA/TIA-568A

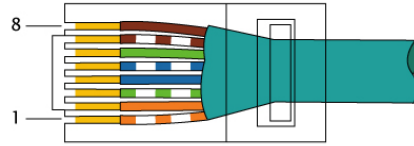

EIA/TIA-568B

2.10.5.7 CONNECTION TO THE INTERNET





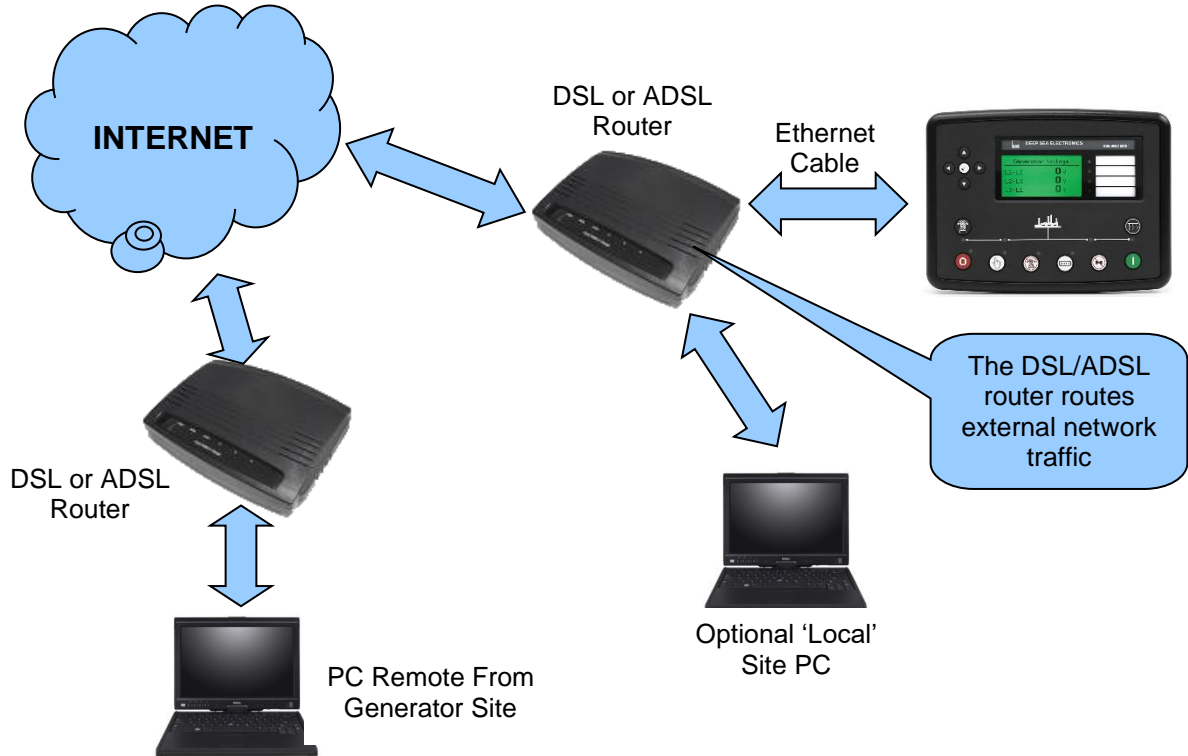





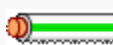



Requirements

- Ethernet cable (see below)
- Working Ethernet (company or home network)
- Working Internet connection (ADSL or DSL recommended)

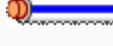
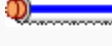

Ethernet Cable Wiring Detail

NOTE: DSE stock 2 m (6.5 feet) Ethernet Cable, DSE Part Number: 016-137. Alternatively they can be purchased from any PC or IT store.

Pin	Connection 1 (T568A)	Connection 2 (T568A)
1	 white/green stripe	 white/green stripe
2	 green solid	 green solid
3	 white/orange stripe	 white/orange stripe
4	 blue solid	 blue solid
5	 white/blue stripe	 white/blue stripe
6	 orange solid	 orange solid
7	 white/brown stripe	 white/brown stripe
8	 brown solid	 brown solid

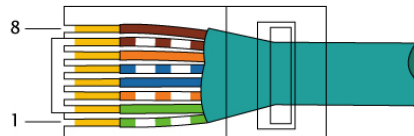

EIA/TIA-568A

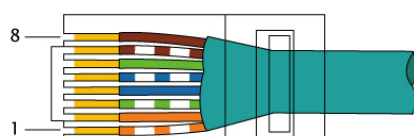

EIA/TIA-568B

2.10.5.8 FIREWALL CONFIGURATION FOR INTERNET ACCESS

 **NOTE: For further details of module configuration, refer to DSE Publication: 057-257 DSE8660 MKII Configuration Suite Software Manual.**

As modem/routers differ enormously in their configuration, it is not possible for DSE to give a complete guide to their use with the module. However it is possible to give a description of the requirements in generic terms. For details of how to achieve the connection to your modem/router you are referred to the supplier of your modem/router equipment.

The module makes its data available over Modbus TCP or SNMP V2c and as such communicates over the Ethernet using a Port configured via the DSE Configuration Suite software.

You must configure your modem/router to allow inbound traffic on this port. For more information you are referred to your WAN interface device (modem/router) manufacturer.

It is also important to note that if the port assigned is already in use on the LAN, the module cannot be used and another port must be used.

Outgoing Firewall Rule

As the module makes its user interface available to standard web browsers, all communication uses the chosen port. It is usual for a firewall to make the same port outgoing open for communication.

Incoming Traffic (Virtual Server)

Network Address and Port Translation (NAPT) allows a single device, such as the modem/router gateway, to act as an agent between the Internet (or "public external network") and a local (or "internal private") network. This means that only a single, unique IP address is required to represent an entire group of computers.

For our application, this means that the WAN IP address of the modem/router is the IP address we need to access the site from an external (internet) location.

When the requests reach the modem/router, we want this passed to a 'virtual server' for handling, in our case this is the module.

Result: Traffic arriving from the WAN (internet) on port xxx is automatically sent to IP address set within the configuration software on the LAN for handling.

2.10.6 MSC (MULTI-SET COMMUNICATIONS) LINK

NOTE: For further details of module configuration, refer to DSE Publication: **057-257 DSE8660 MKII Configuration Suite PC Software Manual.**

NOTE: A termination resistor **MUST** be fitted to the first and last unit on the MSC link. For connection details, refer to section entitled **Typical Arrangement of MSC Link** elsewhere in this document.

NOTE: DSE recommend Belden 9841 (or equivalent) cable for MSC communication. This is rated to a maximum cable length of 250 m. DSE Stock Belden 9841 cable, DSE Part Number: **016-030.**

NOTE: By default the MSC link of the DSE8xxx modules are not compatible with the DSE55xx/DSE75xx modules. For details on enabling compatibility, refer to section entitled **MSC Compatibility** elsewhere in this document.

The MSC link is the interconnection cable between all DSE synchronising controllers and must not be connected to any device other than DSE equipment designed for connection to the MSC link.

Description	Specification
Cable Type	Two core screened and shielded twisted pair
Cable Characteristics	120 Ω Low capacitance
Recommended Cable	Belden 9841 Belden 9271
Maximum Cable Length	<p>NOTE: For additional length, the DSE124 CAN & MSC Extender is available. For more information, refer to DSE Publication: 057-116 DSE124 Operator Manual</p> <p>250 m (273 yards) when using Belden 9841 or direct equivalent. 125 m (136 yards) when using Belden 9271 or direct equivalent.</p>
MSC Topology	“Daisy Chain” Bus with no stubs (spurs)
MSC Termination	120 Ω. Must be fitted externally to the first and last module.
Maximum DSE8xxx and DSE8xxx MKII Modules	<p>NOTE: If any number of DSE8x60 are on the MSC link, a maximum of 2x DSE8x80 can be used. For each DSE8x80 used, the number of available DSE8x60s to be used reduces.</p> <p>Total 40 devices made up of DSE8x10 (up to 32), DSE8x60 (up to 16) and DSE8x80 (up to 16)</p> <p>This gives the possibility of:</p> <ul style="list-style-type: none"> • 32 generators (DSE8x10) and 8 synchronising transfers (DSE8x60) • 32 generators (DSE8x10) and 8 generator bus couplers (DSE8x80) • 24 generators (DSE8x10) and 16 synchronising transfers (DSE8x60) • 24 generators (DSE8x10) and 16 generator bus couplers (DSE8x80) • 32 generators (DSE8x10), 14 synchronising transfers (DSE8x60) and 2 generator bus couplers (DSE8x80)

2.10.8 CAN PORT (REDUNDANT MSC)

NOTE: The redundant MSC link connectivity is only available in DSE8xxx MKII modules V3 and above. Contact DSE technical support: support@deepseaelectronics.com for more information.

NOTE: A termination resistor **MUST** be fitted to the first and last unit on the MSC link. For connection details, refer to section entitled *Typical Arrangement of MSC Link* elsewhere in this document.

NOTE: DSE recommend Belden 9841 (or equivalent) cable for MSC communication. This is rated to a maximum cable length of 250 m. DSE Stock Belden 9841 cable, DSE Part Number: **016-030**.

The additional CAN port can be used as a redundant MSC link between the DSE8xxx MKII modules. The MSC link is the interconnection cable between all DSE synchronising controllers and must not be connected to any device other than DSE equipment designed for connection to the MSC link. Upon the main MSC link failing for any reason, the user can configure the DSE8xxx MKII modules to revert the Redundant MSC Link connection using the CAN Port connection. An example of configuring the Redundant MSC Link connection the DSE Configuration Suite Software is shown below:

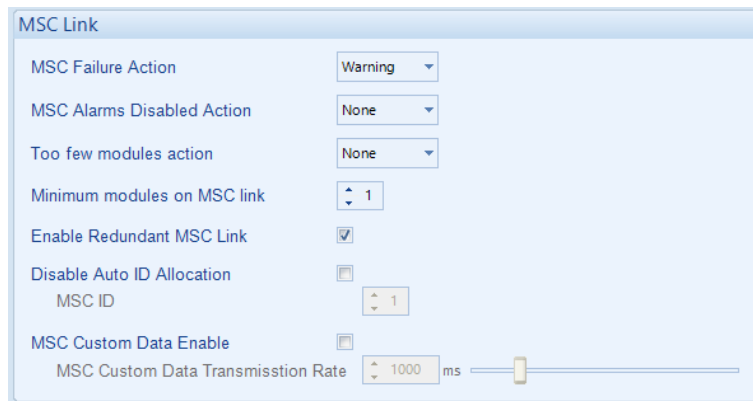

Description	Specification
Cable Type	Two core screened and shielded twisted pair
Cable Characteristics	120 Ω impedance Low capacitance
Recommended Cable	Belden 9841 Belden 9271
Maximum Cable Length	<p>NOTE: For additional length, the DSE124 CAN & MSC Extender is available. For more information, refer to DSE Publication: <i>057-116 DSE124 Operator Manual</i></p> <p>250 m (273 yards) when using Belden 9841 or direct equivalent. 125 m (136 yards) when using Belden 9271 or direct equivalent.</p>

Continued Overleaf...

Specification

Description	Specification
Redundant MSC Topology	"Daisy Chain" Bus with no stubs (spurs)
Redundant MSC Termination	120 Ω. Must be fitted externally to the first and last module.
Maximum DSE8xxx MKII Modules	Total 40 devices made up of DSE8x10 MKII (up to 32) and DSE8x60 MKII (up to 16) This gives the possibility of : <ul style="list-style-type: none"> • 32 generators (DSE8x10 MKII) and 8 synchronising transfers (DSE8x60 MKII) • 24 generators (DSE8x10 MKII) and 16 synchronising transfers (DSE8x60 MKII)

2.10.9 DSENET® (EXPANSION MODULES)

NOTE: For further details of module configuration, refer to DSE Publication: 057-257 *DSE8660 MKII Configuration Suite PC Software Manual*.

NOTE: As a termination resistor is internally fitted to the controller, the controller must be the 'first' unit on the DSENet® link. A termination resistor **MUST** be fitted to the 'last' unit on the DSENet® link. For connection details, refer to section entitled *Typical Arrangement of DSENet®* elsewhere in this document.

NOTE: DSE recommend Belden 9841 (or equivalent) cable for DSENet® communication. This is rated to a maximum cable length of 1.2 km. DSE Stock Belden 9841 cable, DSE Part Number: 016-030.

DSENet® is the interconnection cable between the host controller and the expansion module(s) and must not be connected to any device other than DSE equipment designed for connection to the DSENet®

Description	Specification
Cable Type	Two core screened and shielded twisted pair
Cable Characteristics	120 Ω Low capacitance
Recommended Cable	Belden 9841 Belden 9271
Maximum Cable Length	1200 m (¾ mile) when using Belden 9841 or direct equivalent. 600 m (656 yards) when using Belden 9271 or direct equivalent.
DSENet® Topology	"Daisy Chain" Bus with no stubs (spurs)
DSENet® Termination	120 Ω. Fitted internally to host controller. Must be fitted externally to the 'last' expansion module.
Maximum Expansion Modules	<p>NOTE: Only supported DSE Intelligent Battery Chargers may be connected to the DSENet®. Contact DSE Technical Support for further information.</p> <p>Total 20 devices made up of DSE2130 (up to 4), DSE2131 (up to 4), DSE2133 (up to 4), DSE2152 (up to 4), DSE2157 (up to 10), DSE2548 (up to 10) and DSE Intelligent Battery Chargers (up to 4)</p> <p>This gives the possibility of :</p> <ul style="list-style-type: none"> • Maximum 32 additional 0-10 V or 4-20 mA outputs (DSE2152) • Maximum 80 additional relay outputs (DSE2157) • Maximum 80 additional LED indicators (DSE2548) • Maximum 24 additional RTD or thermocouple inputs (DSE2133). • Maximum 32 additional inputs (Can be configured as either digital, or resistive when using DSE2130) • Maximum 40 additional flexible inputs (All can be configured as either digital, resistive, 0-10 V or 4-20 mA when using DSE2131) • Maximum 4 DSE Intelligent Battery Chargers.

2.11 SOUNDER

The module features an internal sounder to draw attention to warning, electrical trip and shutdown alarms.

Description	Specification
Sounder Level	64 db at 1 m

2.11.1 ADDING AN EXTERNAL SOUNDER

Should an external alarm or indicator be required, this can be achieved by using the DSE Configuration Suite PC software to configure an auxiliary output for *Audible Alarm*, and by configuring an auxiliary input for *Alarm Mute* (if required).

The audible alarm output activates and de-activates at the same time as the module's internal sounder. The Alarm mute input and internal **Lamp Test / Alarm Mute**  button activate 'in parallel' with each other. Either signal mutes both the internal sounder and audible alarm output.

Example of configuration to achieve external sounder with external alarm mute button:

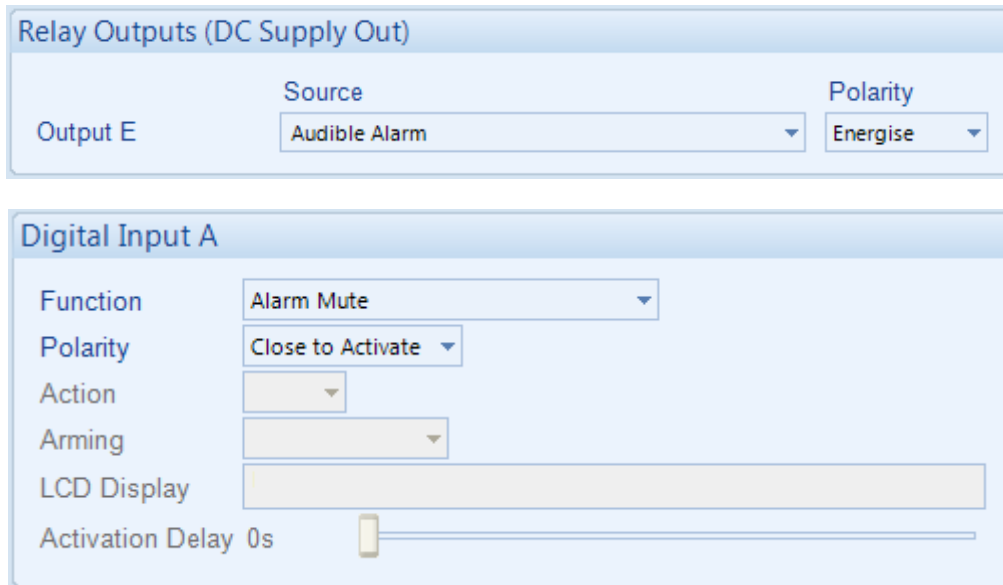

The screenshot shows two configuration panels from the DSE Configuration Suite software. The top panel, titled "Relay Outputs (DC Supply Out)", shows "Output E" configured with "Source" set to "Audible Alarm" and "Polarity" set to "Energise". The bottom panel, titled "Digital Input A", shows "Function" set to "Alarm Mute", "Polarity" set to "Close to Activate", and "Activation Delay" set to "0s".

2.12 ACCUMULATED INSTRUMENTATION

The accumulated power instrumentation can be set/reset using the DSE Configuration Suite PC software. Depending upon module configuration, this may have been PIN number locked by the supplier.

Description	Specification
Accumulated Power	999999 kWh / kvarh / kVAh

2.13 DIMENSIONS AND MOUNTING

2.13.1 DIMENSIONS

245 mm x 184 mm x 51 mm
(9.6" x 7.2" x 2.0")

2.13.2 PANEL CUTOUT

220 mm x 159 mm
(8.7" x 6.3")

2.13.3 WEIGHT

0.98 kg
(2.16 lb)

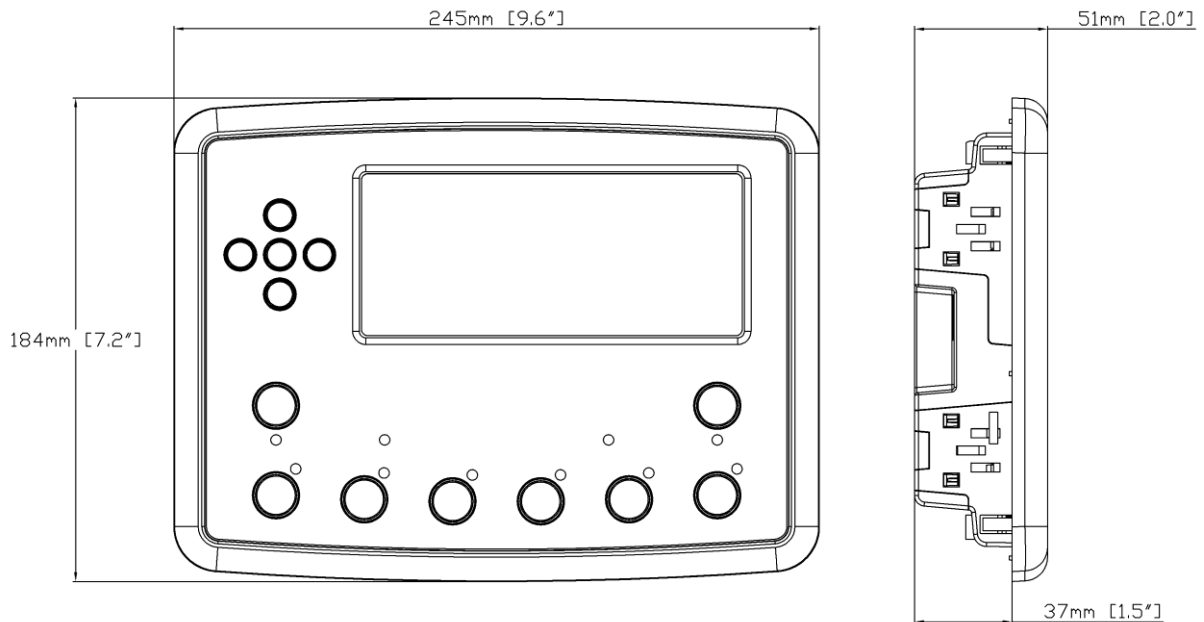

2.13.4 FIXING CLIPS

NOTE: In conditions of excessive vibration, mount the module on suitable anti-vibration mountings.

The module is held into the panel fascia using the supplied fixing clips:

- Withdraw the fixing clip screw (turn anticlockwise) until only the pointed end is protruding from the clip.
- Insert the three 'prongs' of the fixing clip into the slots in the side of the module case.
- Pull the fixing clip backwards (towards the back of the module) ensuring all three prongs of the clip are inside their allotted slots.
- Turn the fixing clip screws clockwise until they make contact with the panel fascia.
- Turn the screw a quarter of a turn to secure the module into the panel fascia. Care must be taken not to over tighten the fixing clip screws.

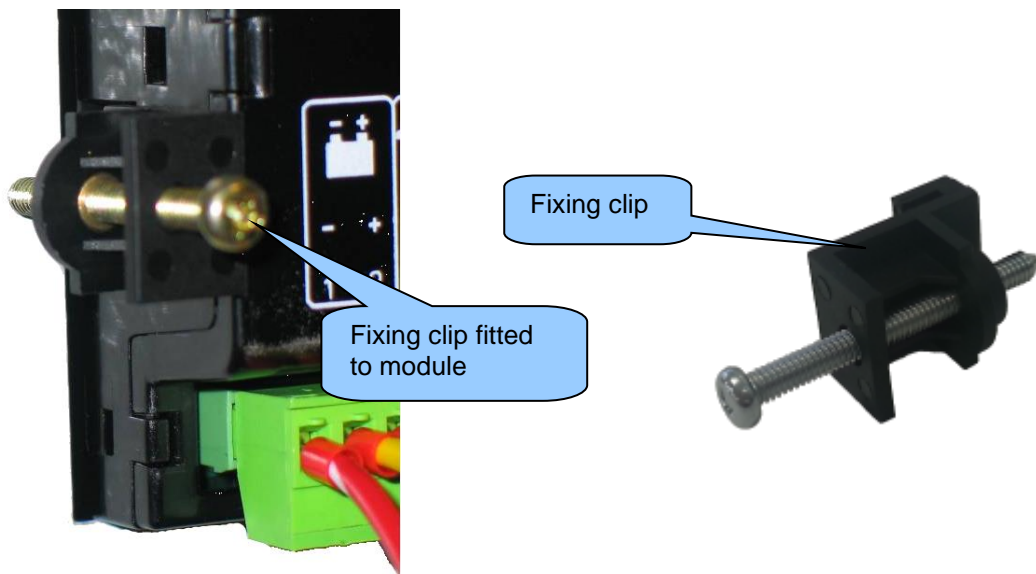

2.13.5 CABLE TIE FIXING POINTS

Cable tie fixing points are included on the rear of the module's case to aid wiring. This additionally provides strain relief to the cable loom by removing the weight of the loom from the screw connectors, reducing the chance of future connection failures.

Care must be taken not to over tighten the cable tie (for instance with cable tie tools) to prevent the risk of damage to the module case.



Cable Tie Fixing Point



With Cable And Tie In Place

2.13.6 SILICON SEALING GASKET

NOTE: For purchasing a silicon gasket from DSE, see the section entitled **Maintenance, Spares, Repair and Servicing** elsewhere in this document.

The silicon gasket provides improved sealing between module and the panel fascia. The gasket is fitted to the module before installation into the panel fascia. Take care to ensure the gasket is correctly fitted to the module to maintain the integrity of the seal.

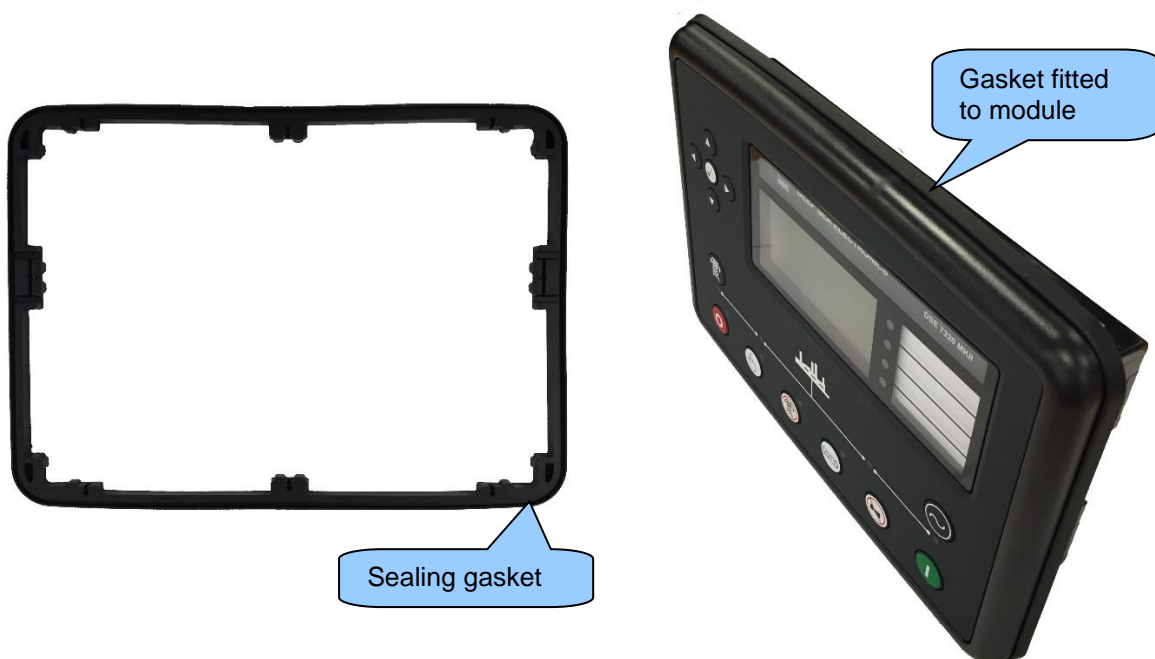

2.14 APPLICABLE STANDARDS

Standard	Description
BS 4884-1	This document conforms to BS4884-1 1992 Specification for presentation of essential information.
BS 4884-2	This document conforms to BS4884-2 1993 Guide to content
BS 4884-3	This document conforms to BS4884-3 1993 Guide to presentation
BS EN 60068-2-1 (Minimum temperature)	-30 °C (-22 °F)
BS EN 60068-2-2 (Maximum temperature)	+70 °C (158 °F)
BS EN 60068-2-6 (Vibration)	Ten sweeps in each of three major axes 5 Hz to 8 Hz at ± 7.5 mm 8 Hz to 500 Hz at 2 gn
BS EN 60068-2-27 (Shock)	Three shocks in each of three major axes 15 gn in 11 ms
BS EN 60068-2-30 (Damp heat cyclic)	20°C to 55 °C at 95% relative humidity for 48 hours
BS EN 60068-2-78 (Damp heat static)	40 °C at 95% relative humidity for 48 hours
BS EN 60950 (Electrical safety)	Safety of information technology equipment, including electrical business equipment
BS EN 61000-6-2 (Electro-magnetic Compatibility)	EMC Generic Immunity Standard (Industrial)
BS EN 61000-6-4 (Electro-magnetic Compatibility)	EMC Generic Emission Standard (Industrial)
BS EN 60529 (Degrees of protection provided by enclosures)	IP65 (front of module when installed into the control panel with the optional sealing gasket) IP42 (front of module when installed into the control panel WITHOUT being sealed to the panel)
UL508 NEMA rating (Approximate)	12 (Front of module when installed into the control panel with the optional sealing gasket). 2 (Front of module when installed into the control panel WITHOUT being sealed to the panel)
IEEE C37.2 (Standard Electrical Power System Device Function Numbers and Contact Designations)	Under the scope of IEEE 37.2, function numbers can also be used to represent functions in microprocessor devices and software programs. The controller is device number 11L-8000 (Multifunction device protecting Line (generator) –module). As the module is configurable by the generator OEM, the functions covered by the module vary. Depending on module configuration, the device numbers included within the module could be: 2 – Time delay starting or closing relay 3 – Checking or interlocking relay 5 – Stopping device 6 – Starting circuit breaker 8 – Control power disconnecting device 10 – Unit sequence switch 11 – Multifunction device 15 – Speed or frequency matching device. 25 – Synchronising or synchronism check relay

Continued over the page...

Specification

Standard	Description
IEEE C37.2 (Standard Electrical Power System Device Function Numbers and Contact Designations)	Continued... 26 – Apparatus thermal device 27AC – AC undervoltage relay 27DC – DC undervoltage relay 29 – Isolating contactor or switch 30 – Annunciator relay 37 – Undercurrent or underpower relay (USING INTERNAL PLC EDITOR) 42 – Running circuit breaker 44 – Unit sequence relay 46 – Reverse-phase or phase-balance current relay 48 – Incomplete sequence relay 50 – Instantaneous overcurrent relay 51 – AC time overcurrent relay 52 – AC circuit breaker 55 – Power factor relay (USING INTERNAL PLC EDITOR) 59AC – AC overvoltage relay 59DC – DC overvoltage relay 62 – Time delay stopping or opening relay 71 – Level switch 74 – Alarm relay 78 – Phase-angle measuring relay 79 – Reclosing relay (USING INTERNAL PLC EDITOR) 81 – Frequency relay 83 – Automatic selective control or transfer relay 86 – Lockout relay

In line with our policy of continual development, Deep Sea Electronics, reserve the right to change specification without notice.

2.14.1 ENCLOSURE CLASSIFICATIONS

2.14.1.1 IP CLASSIFICATIONS

The modules specification under BS EN 60529 Degrees of protection provided by enclosures

IP65 (Front of module when module is installed into the control panel with the optional sealing gasket).
IP42 (front of module when module is installed into the control panel WITHOUT being sealed to the panel)

First Digit	Second Digit
Protection against contact and ingress of solid objects	Protection against ingress of water
0 No protection	0 No protection
1 Protected against ingress solid objects with a diameter of more than 50 mm. No protection against deliberate access, e.g. with a hand, but large surfaces of the body are prevented from approach.	1 Protection against dripping water falling vertically. No harmful effect must be produced (vertically falling drops).
2 Protected against penetration by solid objects with a diameter of more than 12 mm. Fingers or similar objects prevented from approach.	2 Protection against dripping water falling vertically. There must be no harmful effect when the equipment (enclosure) is tilted at an angle up to 15° from its normal position (drops falling at an angle).
3 Protected against ingress of solid objects with a diameter of more than 2.5 mm. Tools, wires etc. with a thickness of more than 2.5 mm are prevented from approach.	3 Protection against water falling at any angle up to 60° from the vertical. There must be no harmful effect (spray water).
4 Protected against ingress of solid objects with a diameter of more than 1 mm. Tools, wires etc. with a thickness of more than 1 mm are prevented from approach.	4 Protection against water splashed against the equipment (enclosure) from any direction. There must be no harmful effect (splashing water).
5 Protected against harmful dust deposits. Ingress of dust is not totally prevented but the dust must not enter in sufficient quantity to interface with satisfactory operation of the equipment. Complete protection against contact.	5 Protection against water projected from a nozzle against the equipment (enclosure) from any direction. There must be no harmful effect (water jet).
6 Protection against ingress of dust (dust tight). Complete protection against contact.	6 Protection against heavy seas or powerful water jets. Water must not enter the equipment (enclosure) in harmful quantities (splashing over).

2.14.1.2 NEMA CLASSIFICATIONS

 NOTE: There is no direct equivalence between IP / NEMA ratings. IP figures shown are approximate only.

12 (Front of module when module is installed into the control panel with the optional sealing gasket).
2 (Front of module when module is installed into the control panel WITHOUT being sealed to the panel)

1	Provides a degree of protection against contact with the enclosure equipment and against a limited amount of falling dirt.
IP30	
2	Provides a degree of protection against limited amounts of falling water and dirt.
IP31	
3	Provides a degree of protection against windblown dust, rain and sleet; undamaged by the formation of ice on the enclosure.
IP64	
3R	Provides a degree of protection against rain and sleet;; undamaged by the formation of ice on the enclosure.
IP32	
4 (X)	Provides a degree of protection against splashing water, windblown dust and rain, hose directed water; undamaged by the formation of ice on the enclosure. (Resist corrosion).
IP66	
12/12K	Provides a degree of protection against dust, falling dirt and dripping non corrosive liquids.
IP65	
13	Provides a degree of protection against dust and spraying of water, oil and non corrosive coolants.
IP65	

3 INSTALLATION

The module is designed to be mounted on the panel fascia. For dimension and mounting details, see the section entitled *Dimension and Mounting* elsewhere in this document.

3.1 USER CONNECTIONS

NOTE: Availability of some terminals depends upon module version. Full details are given in the section entitled *Terminal Description* elsewhere in this manual.

To aid user connection, icons are used on the rear of the module to help identify terminal functions. An example of this is shown below.

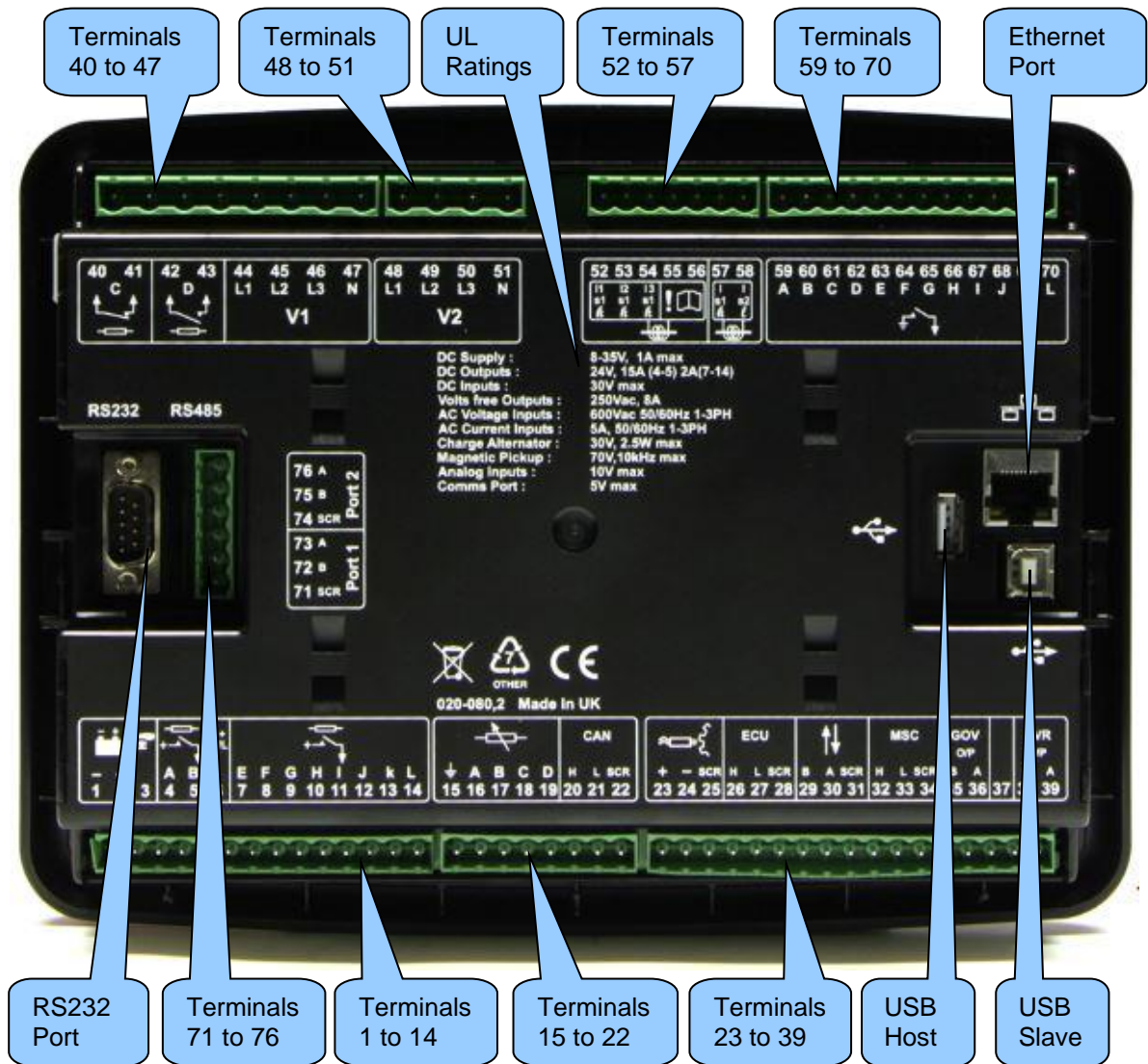





3.2 CONNECTION DESCRIPTIONS

3.2.1 DC SUPPLY & DC OUTPUTS

 **NOTE:** When the module is configured for operation with an electronic engine, *Fuel* and *Start* output requirements may be different. For further details on connection to electronic engines, refer to DSE Publication: *057-004 Electronic Engines And DSE Wiring*

 **NOTE:** For further details of module configuration, refer to DSE Publication: *057-257 DSE8660 MKII Configuration Suite PC Software Manual.*

	Pin No	Description	Cable Size	Notes
	1	DC Plant Supply Input (Negative)	2.5 mm ² AWG 13	Connect to ground where applicable.
	2	DC Plant Supply Input (Positive)	2.5 mm ² AWG 13	Supplies the module and DC Outputs E, F, G, H, I & J
	3	Not Connected		
	4	Not Connected		
	5	Not Connected		
D+ W/L	6	Not Connected		
	7	DC Output E	1.0 mm ² AWG 18	Plant Supply Positive from terminal 2. 2 A DC rated.
	8	DC Output F	1.0 mm ² AWG 18	Plant Supply Positive from terminal 2. 2 A DC rated.
	9	DC Output G	1.0 mm ² AWG 18	Plant Supply Positive from terminal 2. 2 A DC rated.
	10	DC Output H	1.0 mm ² AWG 18	Plant Supply Positive from terminal 2. 2 A DC rated.
	11	DC Output I	1.0 mm ² AWG 18	Plant Supply Positive from terminal 2. 2 A DC rated.
	12	DC Output J	1.0 mm ² AWG 18	Plant Supply Positive from terminal 2. 2 A DC rated.
	13	Not Connected		
	14	Not Connected		

3.2.2 CAN

 **NOTE:** For further details of module configuration, refer to DSE Publication: *057-257 DSE8660 MKII Configuration Suite Software Manual*.

 **NOTE:** Screened 120 Ω impedance cable specified for use with CAN must be used for the CAN & MSC links.
DSE stock and supply Belden cable 9841 which is a high quality 120 Ω impedance cable suitable for CAN use (DSE part number 016-030)



	Pin No	Description	Cable Size	Notes
	15	Not Connected		
	16	Not Connected		
	17	Not Connected		
	18	Not Connected		
	19	Not Connected		
CAN	20	CAN Port H	0.5 mm ² AWG 20	Use only 120 Ω CAN or RS485 approved cable
	21	CAN Port L	0.5 mm ² AWG 20	Use only 120 Ω CAN or RS485 approved cable
	22	CAN Port Screen	Shield	Use only 120 Ω CAN or RS485 approved cable

3.2.3 MSC & DSENET®

 **NOTE:** For further details of module configuration, refer to DSE Publication: 057-257 *DSE8660 MKII Configuration Suite PC Software Manual*.



 **NOTE:** Screened 120 Ω impedance cable specified for use with CAN must be used for the MSC link.
DSE stock and supply Belden cable 9841 which is a high quality 120 Ω impedance cable suitable for CAN use (DSE part number 016-030)

 **NOTE:** As a termination resistor is internally fitted to the controller, the controller must be the 'first' unit on the DSENet® link. A termination resistor **MUST** be fitted to the 'last' unit on the DSENet® link. For connection details, refer to section entitled *Typical Wiring Diagram* elsewhere in this document.

	Pin No	Description	Cable Size	Notes
	23	Not Connected		
	24	Not Connected		
	25	Not Connected		
ECU	26	Not Connected		
	27	Not Connected		
	28	Not Connected		
	29	DSENet® Expansion B	0.5 mm ² AWG 20	Use only 120 Ω CAN or RS485 approved cable
	30	DSENet® Expansion A	0.5 mm ² AWG 20	Use only 120 Ω CAN or RS485 approved cable
	31	DSENet® Expansion Screen	Shield	Use only 120 Ω CAN or RS485 approved cable
MSC	32	MSC Port H	0.5 mm ² AWG 20	Use only 120 Ω CAN or RS485 approved cable
	33	MSC Port L	0.5 mm ² AWG 20	Use only 120 Ω CAN or RS485 approved cable
	34	MSC Port Screen	Shield	Use only 120 Ω CAN or RS485 approved cable
GOV	35	Not Connected		
	36	Not Connected		
		Not Connected		
AVR	38	Not Connected		
	39	Not Connected		

3.2.4 OUTPUT C & D & V1 (MAINS) VOLTAGE & FREQUENCY SENSING

NOTE: The below table describes connections to a three phase, four wire supply. For alternative wiring topologies, see the section entitled *Alternate Topology Wiring Diagrams* elsewhere in this document.

	Pin No	Description	Cable Size	Notes
	40	Normally Closed Volt-Free Relay Output C	1.0mm ² AWG 18	Normally configured to control the mains contactor coil
	41		1.0mm ² AWG 18	
	42	Normally Open Volt-Free Relay Output D	1.0mm ² AWG 18	Normally configured to control the bus contactor coil
	43		1.0mm ² AWG 18	
V1	44	Mains L1 (R) Voltage Sensing	1.0 mm ² AWG 18	Connect to mains L1 (R) output (AC) (Recommend 2 A fuse)
	45	Mains L2 (S) Voltage Sensing	1.0 mm ² AWG 18	Connect to mains L2 (S) output (AC) (Recommend 2 A fuse)
	46	Mains L3 (T) Voltage Sensing	1.0 mm ² AWG 18	Connect to mains L3 (T) output (AC) (Recommend 2 A fuse)
	47	Mains Neutral (N) Input	1.0 mm ² AWG 18	Connect to mains Neutral terminal (AC)

3.2.5 V2 (BUS) VOLTAGE & FREQUENCY SENSING

NOTE: The below table describes connections to a three phase, four wire Bus supply. For alternative wiring topologies, see the section entitled *Alternate Topology Wiring Diagrams* elsewhere in this document.

	Pin No	Description	Cable Size	Notes
V2	48	Bus L1 (U) Voltage Sensing	1.0 mm ² AWG 18	Connect to Bus L1 (U) output (AC) (Recommend 2 A fuse)
	49	Bus L2 (V) Voltage Sensing	1.0 mm ² AWG 18	Connect to Bus L2 (V) output (AC) (Recommend 2 A fuse)
	50	Bus L3 (W) Voltage Sensing	1.0 mm ² AWG 18	Connect to Bus L3 (W) output (AC) (Recommend 2 A fuse)
	51	Bus Neutral (N) Input	1.0 mm ² AWG 18	Connect to Bus Neutral terminal (AC)

3.2.6 CURRENT TRANSFORMERS

 **WARNING!** Do not disconnect this plug when the CTs are carrying current. Disconnection will open circuit the secondary of the C.T.'s and dangerous voltages may then develop. Always ensure the CTs are not carrying current and the CTs are short circuit connected before making or breaking connections to the module.

 **NOTE:** The module has a burden of 0.5 VA on the CT. Ensure the CT is rated for the burden of the controller, the cable length being used and any other equipment sharing the CT. If in doubt, consult your CT supplier.

 **NOTE:** Take care to ensure correct polarity of the CT primary as shown below. If in doubt, check with the CT supplier.

3.2.6.1 MAINS CURRENT TRANSFORMERS

	Pin No	Description	Cable Size	Notes
	52	CT Secondary for Mains L1	2.5 mm ² AWG 13	Connect to s1 secondary of L1 monitoring CT
	53	CT Secondary for Mains L2	2.5 mm ² AWG 13	Connect to s1 secondary of L2 monitoring CT
	54	CT Secondary for Mains L3	2.5 mm ² AWG 13	Connect to s1 secondary of L3 monitoring CT
	55	DO NOT CONNECT		
	56	Common for CTs connected to L1,L2,L3 (s2)	2.5 mm ² AWG 13	Connect to s2 secondary of L1,L2,L3 monitoring CTs

3.2.6.2 BUS/LOAD CURRENT TRANSFORMER

 **NOTE:** The Bus/Load CT is NOT REQUIRED in a system including only one DSE8x60 controller.

	Pin No	Description	CABLE SIZE	NOTES
	57	CT Secondary for Bus/Load CT	2.5 mm ² AWG 13	Connect to s1 secondary of Bus/Load CT
	58	CT Secondary for Bus/Load CT	2.5 mm ² AWG 13	Connect to s2 secondary of Bus/Load CT

Advantages of Bus/Load CT

The Bus/Load CT is only required when there is **more than one** DSE8x60 in the same system.

When the Bus/Load CT is fitted, the DSE8x60 transfers the correct amount of load to the mains before disconnecting the generator bus, preventing the generator(s) from being shock loaded/unloaded.

Without the Bus/Load CT, the DSE8x60 does not know how much load to transfer to the mains when other DSE8x60's are still operating in island mode. Instead, the DSE8x60 would open the bus breaker at a pre-determined load level on the mains. This may lead to there being too much load or not enough load transferred, and the generator(s) may be shock loaded/unloaded as the bus disconnect from the mains.

3.2.6.3 CT CONNECTIONS

p1, κ or K is the primary of the CT that 'points' towards the Generator

p2, ℓ or L is the primary of the CT that 'points' towards the Load

s1 is the secondary of the CT that connects to the DSE Module's input for the CT measuring

s2 is the secondary of the CT that should be commoned with the s2 connections of all the other CTs and connected to the CT common terminal of the module.

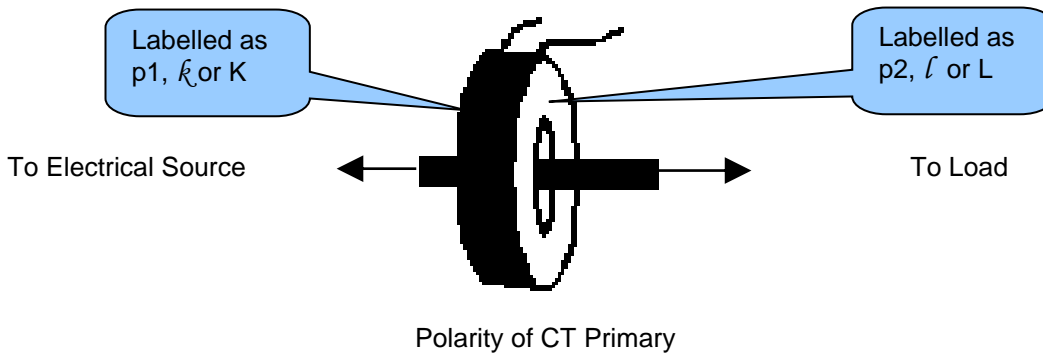

3.2.7 DIGITAL INPUTS

NOTE: For further details of module configuration, refer to DSE Publication: 057-257 *DSE8660 MKII Configuration Suite PC Software Manual*.

Pin No	Description	Cable Size	Notes	
	59	Configurable Digital Input A	0.5 mm ² AWG 20	Switch To Negative
	60	Configurable Digital Input B	0.5 mm ² AWG 20	Switch To Negative
	61	Configurable Digital Input C	0.5 mm ² AWG 20	Switch To Negative
	62	Configurable Digital Input D	0.5 mm ² AWG 20	Switch To Negative
	63	Configurable Digital Input E	0.5 mm ² AWG 20	Switch To Negative
	64	Configurable Digital Input F	0.5 mm ² AWG 20	Switch To Negative
	65	Configurable Digital Input G	0.5 mm ² AWG 20	Switch To Negative
	66	Configurable Digital Input H	0.5 mm ² AWG 20	Switch To Negative
	67	Configurable Digital Input I	0.5 mm ² AWG 20	Switch To Negative
	68	Configurable Digital Input J	0.5 mm ² AWG 20	Switch To Negative
	69	Configurable Digital Input K	0.5 mm ² AWG 20	Switch To Negative
	70	Configurable Digital Input L	0.5 mm ² AWG 20	Switch To Negative

3.2.8 RS485

NOTE: For further details of module configuration, refer to DSE Publication: 057-257 *DSE8660 MKII Configuration Suite PC Software Manual*.

NOTE: A 120 Ω termination resistor must be fitted across terminals A and B if the DSE module is the first or last device on the R485 link.

NOTE: Screened 120 Ω impedance cable specified for use with RS485 must be used for the RS485 link.
DSE stock and supply Belden cable 9841 which is a high quality 120 Ω impedance cable suitable for CAN use (DSE part number 016-030)

	Pin No	Description	Cable Size	Notes
RS485 1	71	RS485 Port Screen	Shield	Use only 120 Ω CAN or RS485 approved cable
	72	RS485 Port B (+)	0.5 mm ² AWG 20	Connect to RXD+ and TXD+ Use only 120 Ω CAN or RS485 approved cable
	73	RS485 Port A (-)	0.5 mm ² AWG 20	Connect to RXD- and TXD- Use only 120 Ω CAN or RS485 approved cable
RS485 2	74	RS485 Port Screen	Shield	Use only 120 Ω CAN or RS485 approved cable
	75	RS485 Port B (+)	0.5 mm ² AWG 20	Connect to RXD+ and TXD+ Use only 120 Ω CAN or RS485 approved cable
	76	RS485 Port A (-)	0.5 mm ² AWG 20	Connect to RXD- and TXD- Use only 120 Ω CAN or RS485 approved cable

3.2.9 RS232

NOTE: For further details of module configuration, refer to DSE Publication: 057-257 *DSE8660 MKII Configuration Suite PC Software Manual.*

Description	Notes
 <p>Socket for connection to a modem or PC with DSE Configuration Suite Software</p>	Supports MODBUS RTU protocol or external modem

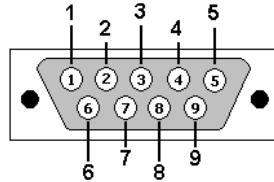

View looking into the male connector on the module



PIN No	Notes
1	Received Line Signal Detector (Data Carrier Detect)
2	Received Data
3	Transmit Data
4	Data Terminal Ready
5	Signal Ground
6	Data Set Ready
7	Request To Send
8	Clear To Send
9	Ring Indicator

3.2.10 USB SLAVE (PC CONFIGURATION) CONNECTOR

NOTE: The USB connection cable between the PC and the module must not be extended beyond 5 m (16 feet). For distances over 5 m, it is possible to use a third party USB extender. Typically, they extend USB up to 50 m. The supply and support of this type of equipment is outside the scope of Deep Sea Electronics.

CAUTION! Care must be taken not to overload the PC's USB system by connecting more than the recommended number of USB devices to the PC. For further information, consult your PC supplier.

NOTE: For further details of module configuration, refer to DSE Publication: 057-257 *DSE8660 MKII Configuration Suite PC Software Manual*.

	Description	Cable Size	Notes
	Socket for connection to PC with DSE Configuration Suite Software	0.5 mm ² AWG 20	This is a standard USB type A to type B connector. 

3.2.11 USB HOST (DATA LOGGING) CONNECTOR

NOTE: For further details on how to add and remove a USB storage device, refer to section entitled *Data Logging Pages* elsewhere in this document.

NOTE: For further details of module configuration, refer to DSE Publication: 057-257 *DSE8660 MKII Configuration Software Manual*.

	Description	Storage Size	Notes
	Socket for connection to USB storage device for data logging	Maximum 16 GB	USB storage device must be formatted as FAT32.

3.3 TYPICAL WIRING DIAGRAM

 **NOTE: It is recommended that the mains load switch uses DC coils/shunts for opening control and that no UV (under voltage) coils are fitted.**

As every system has different requirements, these diagrams show only a typical system and do not intend to show a complete system.

Genset manufacturers and panel builders may use these diagrams as a starting point; however always refer to the completed system diagram provided by the system manufacturer for complete wiring detail.

Further wiring suggestions are available in the following DSE publications, available at www.deepseaelectronics.com to website members.

DSE Part	Description
056-022	Breaker Control (Training guide)
056-005	Using CTs With DSE Products
056-022	Breaker Control
056-091	Equipotential Earth Bonding
056-092	Best Practices for Wiring Resistive Sensors

3.3.1 3 PHASE, 4 WIRE WITH A BUS CT

NOTE: The below diagram is applicable for the following AC topologies: 3 Phase 4 Wire Star, 3 Phase 4 Wire Delta L1-N-L2, 3 Phase 4 Wire Delta L1-N-L3 and 3 Phase 4 Wire Delta L2-N-L3. For further details of module configuration to suit these different topologies, refer to DSE Publication: 057-257 *DSE8660 MKII Configuration Suite Software Manual*.

NOTE: The Bus/Load CT is NOT REQUIRED in a system including only one DSE8x60 controller. For further information regarding the advantages of a Bus/Load CT, refer to section entitled *Bus/Load Current Transformer* elsewhere in this document, or refer to DSE Publication: 056-007 *Advantages of Bus/Load CT*.

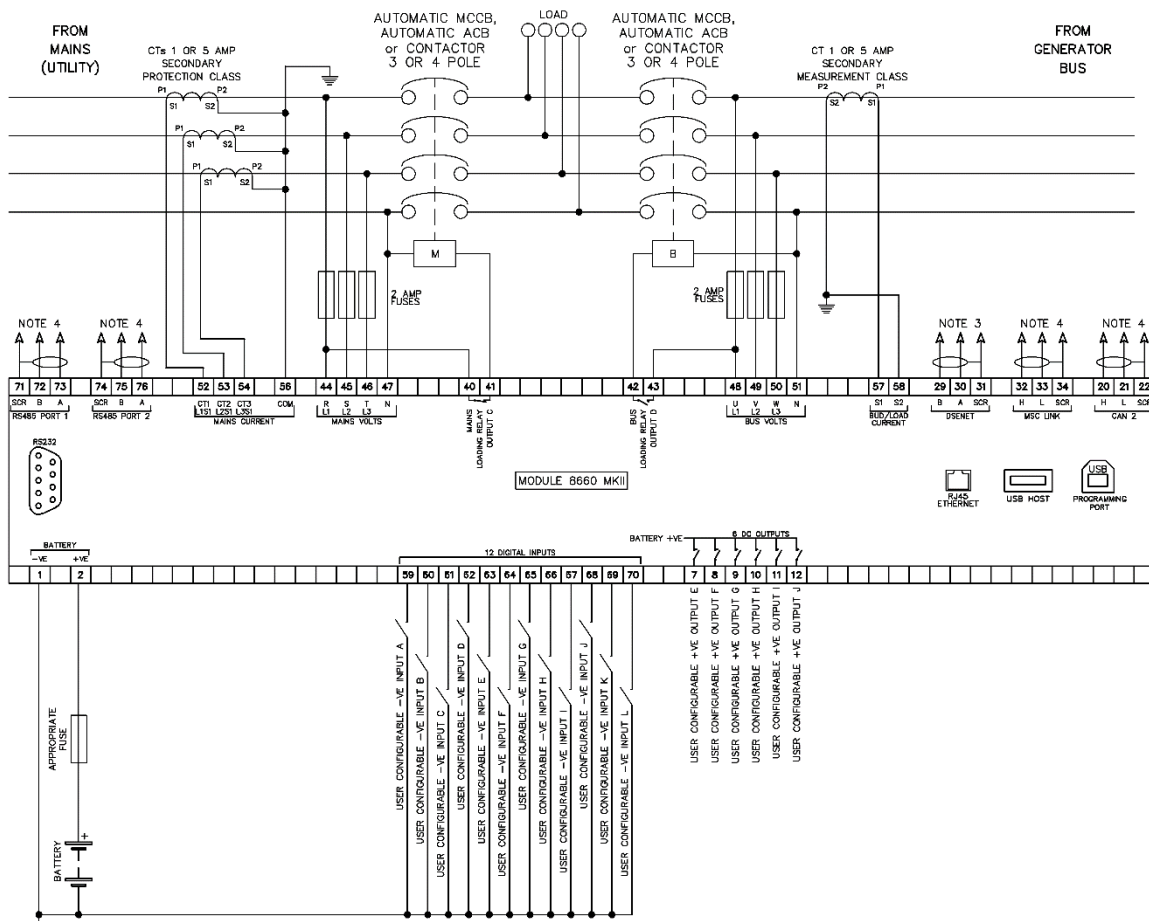

BATTERY NEGATIVE MUST BE GROUNDING

NOTE 1. THESE GROUND CONNECTIONS MUST BE ON THE ENGINE BLOCK, AND MUST BE TO THE SENSOR BODIES.

NOTE 2. 120 OHM TERMINATING RESISTOR MAY BE REQUIRED EXTERNALLY. SEE ENGINE MANUFACTURERS LITERATURE.

NOTE 3. MUST BE FITTED AS FIRST OR LAST UNIT ON DSENET WITH NO TERMINATION RESISTOR. THE SUBSEQUENT FIRST OR LAST UNIT ON DSENET MUST BE FITTED WITH A 120 OHM TERMINATION RESISTOR ACROSS TERMINALS A AND B.

NOTE 4. IF THE MODULE IS FIRST OR LAST UNIT ON THE LINK, IT MUST BE FITTED WITH A 120 OHM TERMINATION RESISTOR ACROSS TERMINALS H AND L.

3.3.2 EARTH SYSTEMS

3.3.2.1 NEGATIVE EARTH

The typical wiring diagrams located within this document show connections for a negative earth system (the battery negative connects to Earth).

3.3.2.2 POSITIVE EARTH

When using a DSE module with a Positive Earth System (the battery positive connects to Earth), the following points must be followed:

Follow the typical wiring diagram as normal for all sections **except** the earth points. All points shown as Earth on the typical wiring diagram should connect to **battery negative** (not earth).

3.3.2.3 FLOATING EARTH

Where neither the battery positive nor battery negative terminals are connected to earth the following points must to be followed:

Follow the typical wiring diagram as normal for all sections **except** the earth points. All points shown as Earth on the typical wiring diagram should connect to **battery negative** (not earth).

3.3.3 TYPICAL ARRANGEMENT OF DSENET®

NOTE: For further details of module configuration, refer to DSE Publication: *057-257 DSE8660 MKII Configuration Suite Software Manual*.

NOTE: Screened 120 Ω impedance cable specified for use with CAN must be used for the DSENet® (RS485) connection.

DSE stock and supply Belden cable 9841 which is a high quality 120Ω impedance cable suitable for DSENet® use (DSE part number 016-030)

Twenty (20) devices can be connected to the DSENet®, made up of the following devices :

Device	Maximum Number Supported
DSE2130 Input Expansion	4
DSE2131 Input Expansion	4
DSE2133 Input Expansion	4
DSE2152 Relay Output Expansion	4
DSE2157 Relay Output Expansion	10
DSE2548 LED Expansion	10
DSE Intelligent Battery Chargers	4

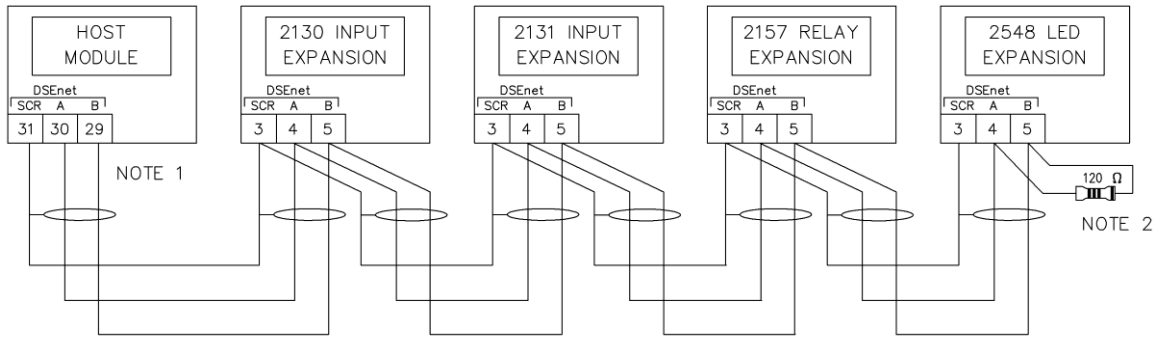

NOTE 1
 AS A TERMINATING RESISTOR IS INTERNALLY FITTED TO THE HOST CONTROLLER, THE HOST CONTROLLER MUST BE THE FIRST UNIT ON THE DSEnet

NOTE 2
 A 120 OHM TERMINATION RESISTOR MUST BE FITTED TO THE LAST UNIT ON THE DSEnet

3.3.4 TYPICAL ARRANGEMENT OF MSC LINK

NOTE: For further information on the maximum number of module that can be connected to the MSC link and Redundant MSC link, refer to sections entitled *MSC (Multi-Set Communications) Link* and *CAN Port (Redundant MSC)* elsewhere in this document.

NOTE: For further details of module configuration, refer to DSE Publication: *057-257 DSE8660 MKII Configuration Suite Software Manual*.

NOTE: Screened 120 Ω impedance cable specified for use with CAN must be used for the MSC link connection.

DSE stock and supply Belden cable 9841 which is a high quality 120 Ω impedance cable suitable for MSC link (DSE part number 016-030)

NOTE: A termination resistor **MUST** be fitted to the first and last unit on the MSC link.

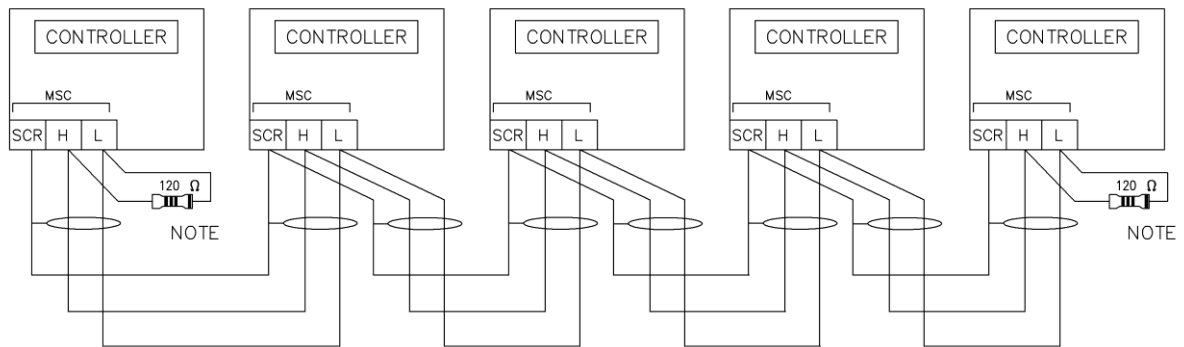

NOTE
A 120 OHM TERMINATION RESISTOR MUST BE FITTED
TO THE FIRST AND LAST UNIT ON THE MSC LINK

3.4 ALTERNATE TOPOLOGY WIRING DIAGRAMS

NOTE: For further details of module configuration, refer to DSE Publication: *057-257 DSE8660 MKII Configuration Software Manual*.

NOTE: The Bus/Load CT is NOT REQUIRED in a system including only one DSE8x60 controller. For further information regarding the advantages of a Bus/Load CT, refer to section entitled *Bus/Load Current Transformer* elsewhere in this document, or refer to DSE Publication: *056-007 Advantages of Bus/Load CT*.

The controller is factory configured to connect to a 3 Phase, 4 Wire Star connected system. This section details connections for alternative AC topologies. Ensure to configure the controller to suit the required topology.

3.4.1 SINGLE PHASE (L1 & N) 2 WIRE WITH A BUS CT

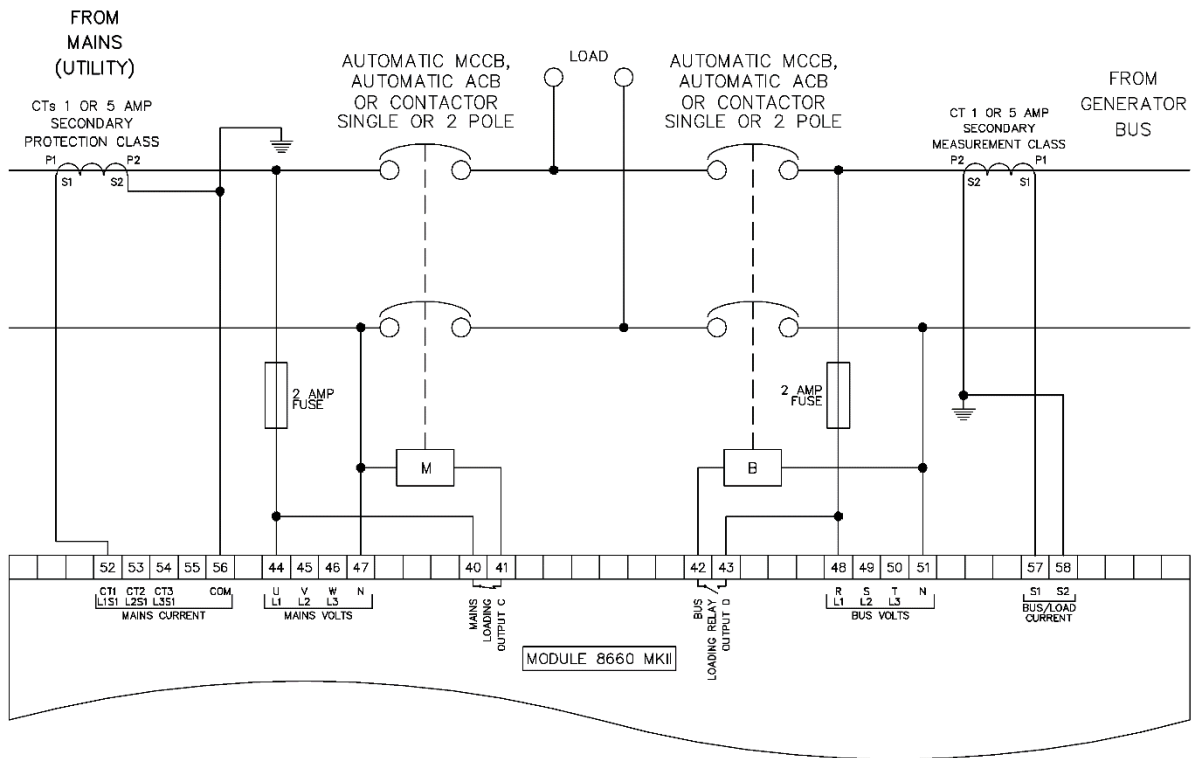

3.4.2 SINGLE PHASE (L1 & L2) 3 WIRE WITH A BUS CT

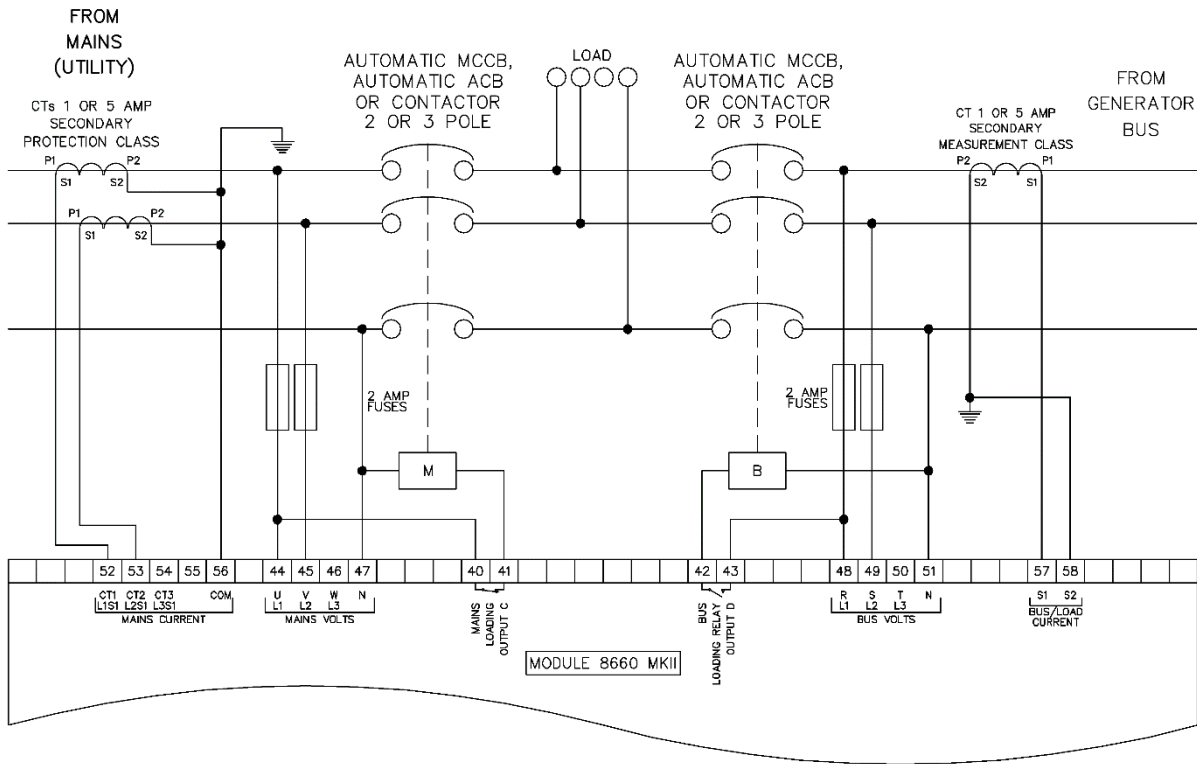

3.4.3 SINGLE PHASE (L1 & L3) 3 WIRE WITH A BUS CT

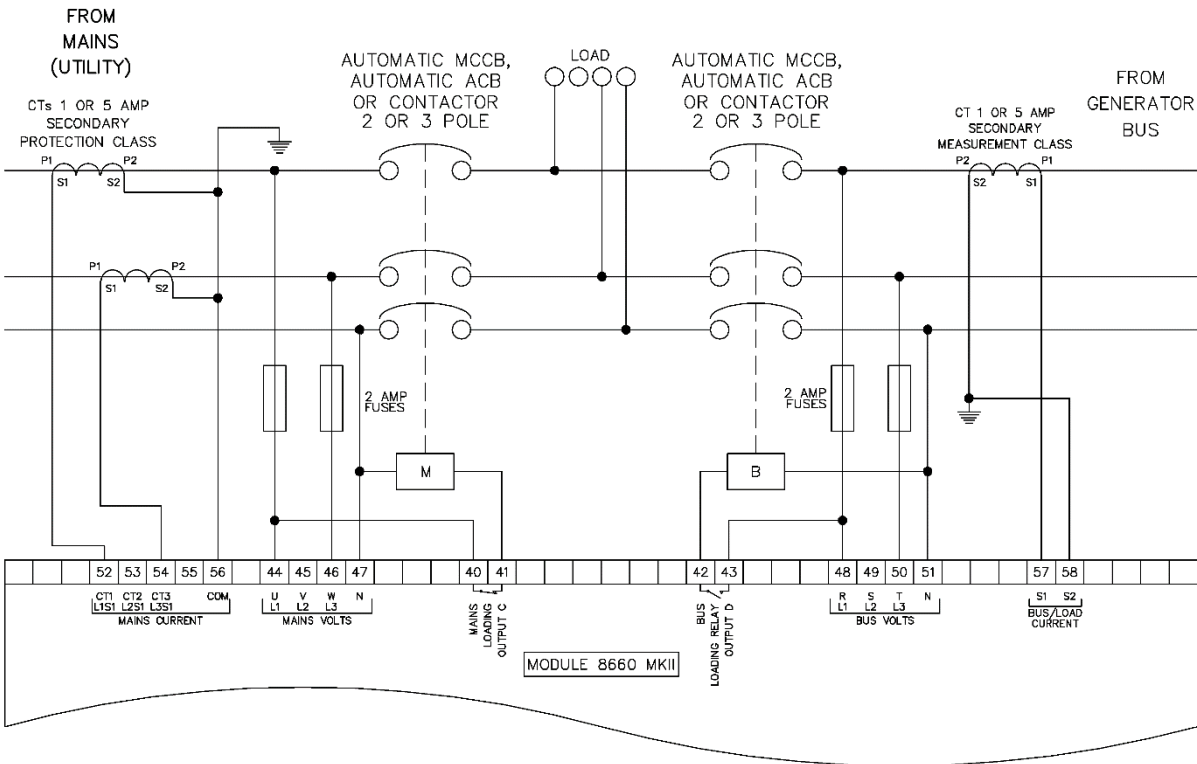

3.4.4 2 PHASE (L1 & L2) 3 WIRE WITH A BUS CT

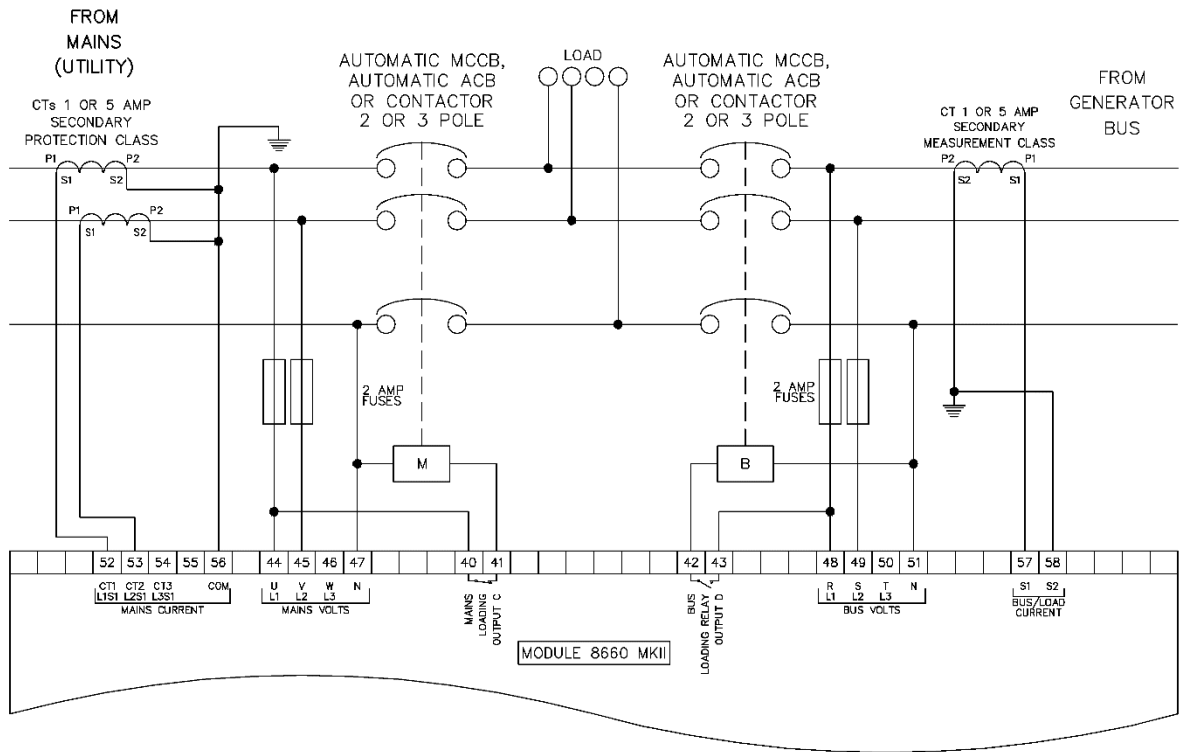

3.4.5 2 PHASE (L1 & L3) 3 WIRE WITH A BUS CT

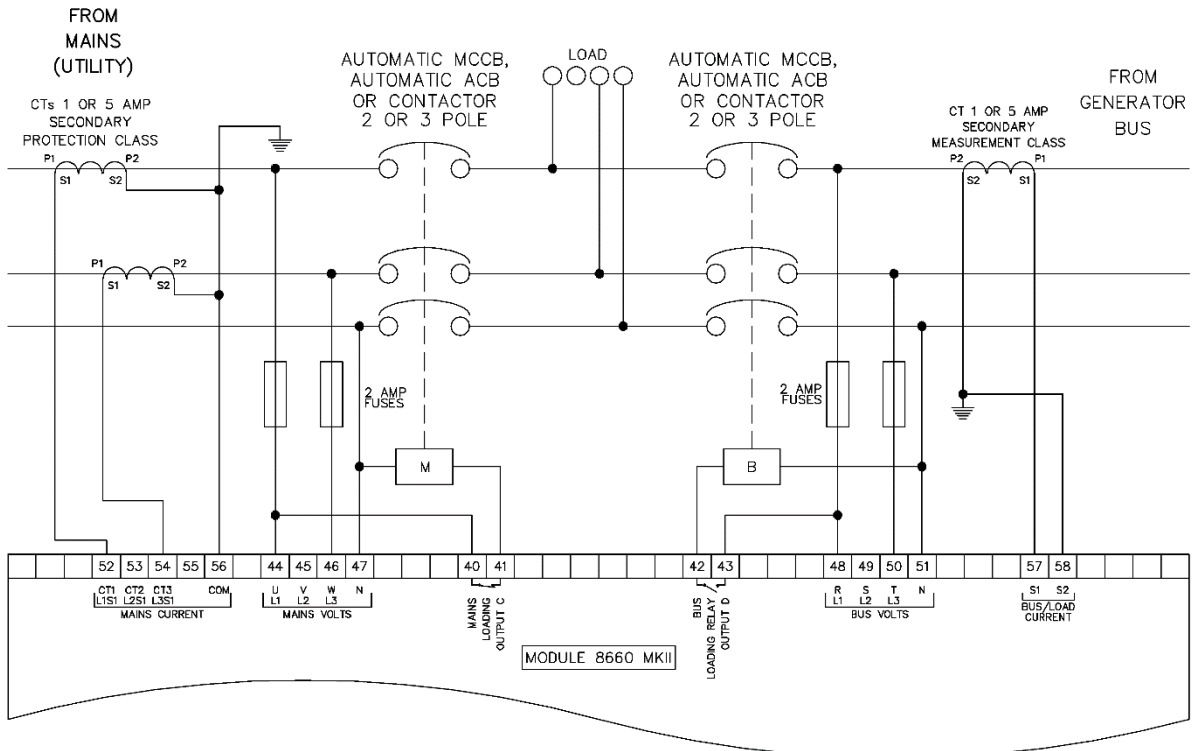

3.4.6 3 PHASE 3 WIRE DELTA WITH A BUS CT

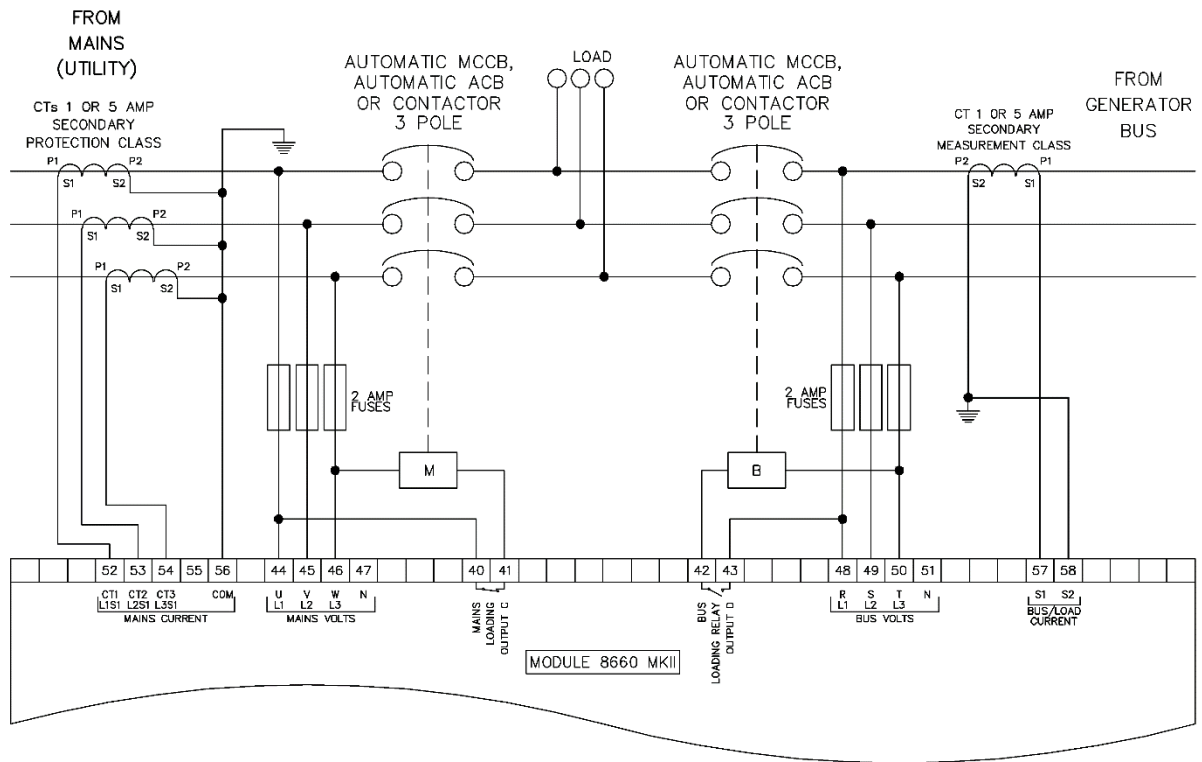

3.4.7 3 PHASE, 4 WIRE WITH A BUS CT

NOTE: The below diagram is applicable for the following AC topologies: 3 Phase 4 Wire Star, 3 Phase 4 Wire Delta L1-N-L2, 3 Phase 4 Wire Delta L1-N-L3 and 3 Phase 4 Wire Delta L2-N-L3. For further details of module configuration to suit these different topologies, refer to DSE Publication: 057-257 *DSE8660 MKII Configuration Suite Software Manual*.

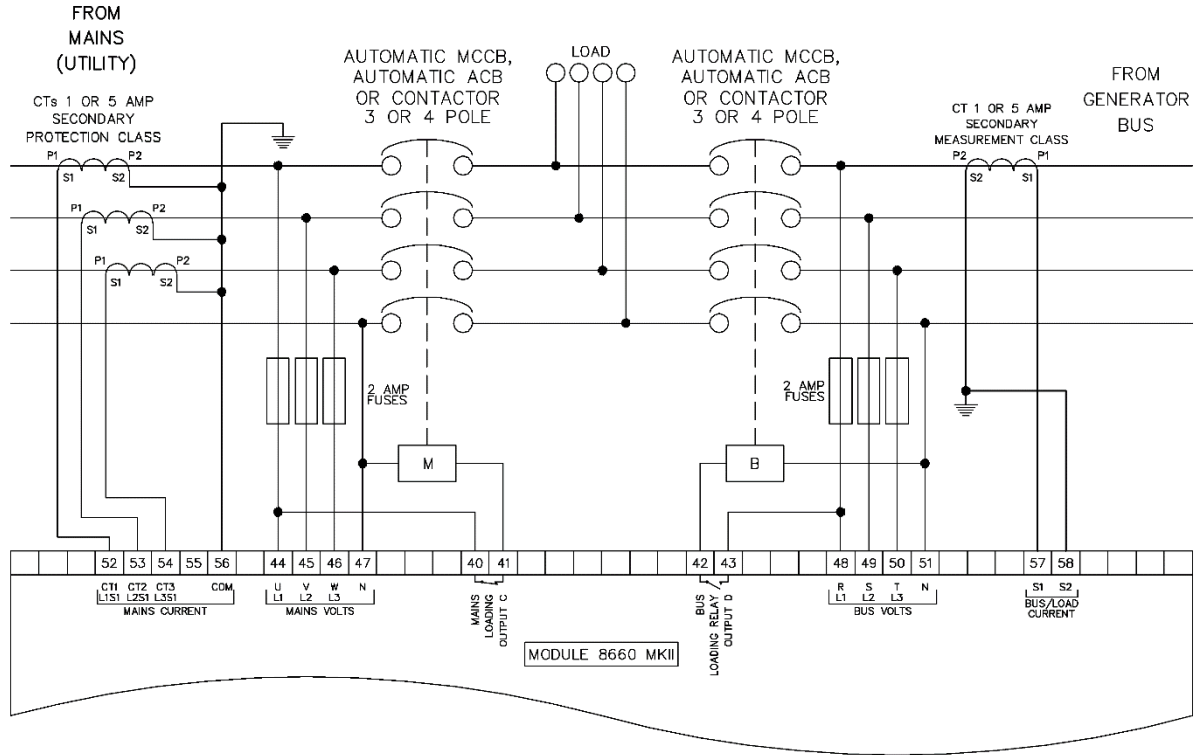

3.4.8 3 PHASE, 4 WIRE WITH A LOAD CT

NOTE: The below diagram is applicable for the following AC topologies: 3 Phase 4 Wire Star, 3 Phase 4 Wire Delta L1-N-L2, 3 Phase 4 Wire Delta L2-N-L3 and 3 Phase 4 Wire Delta L2-N-L3. For further details of module configuration to suit these different topologies, refer to DSE Publication: 057-257 *DSE8660 MKII Configuration Suite Software Manual*.

This example shows the Bus/Load CT in the common load feed for a three phase four wire system but the same philosophy is applicable to the other topologies

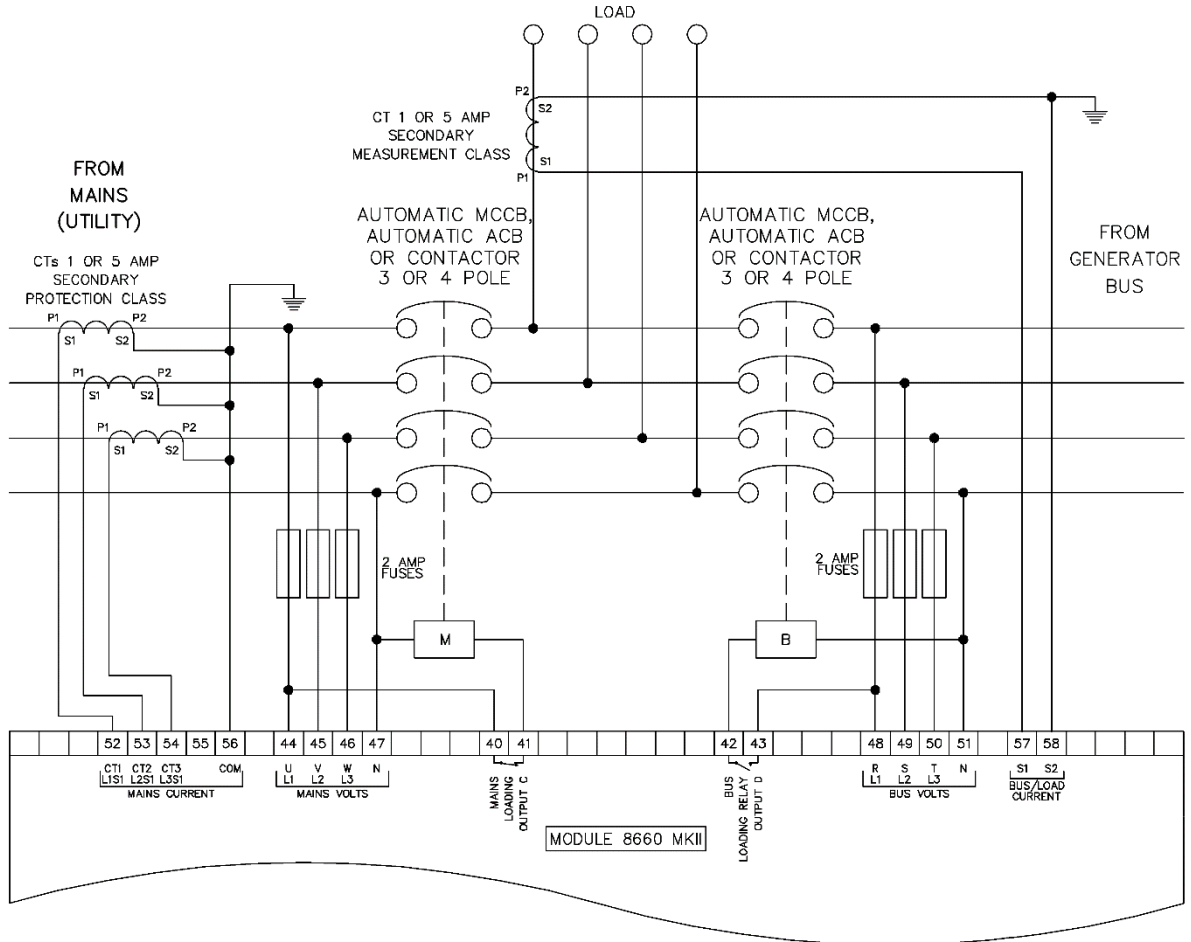

3.5 TYPICAL SINGLE LINE APPLICATION DRAWINGS

3.5.1 MULTI GENERATORS FOR PRIME POWER

NOTE: The below diagram is available in a larger scale. Contact DSE technical support for further information, support@deepseelectronics.com.

MSC LINK. 120 OHM SCREENED CABLE

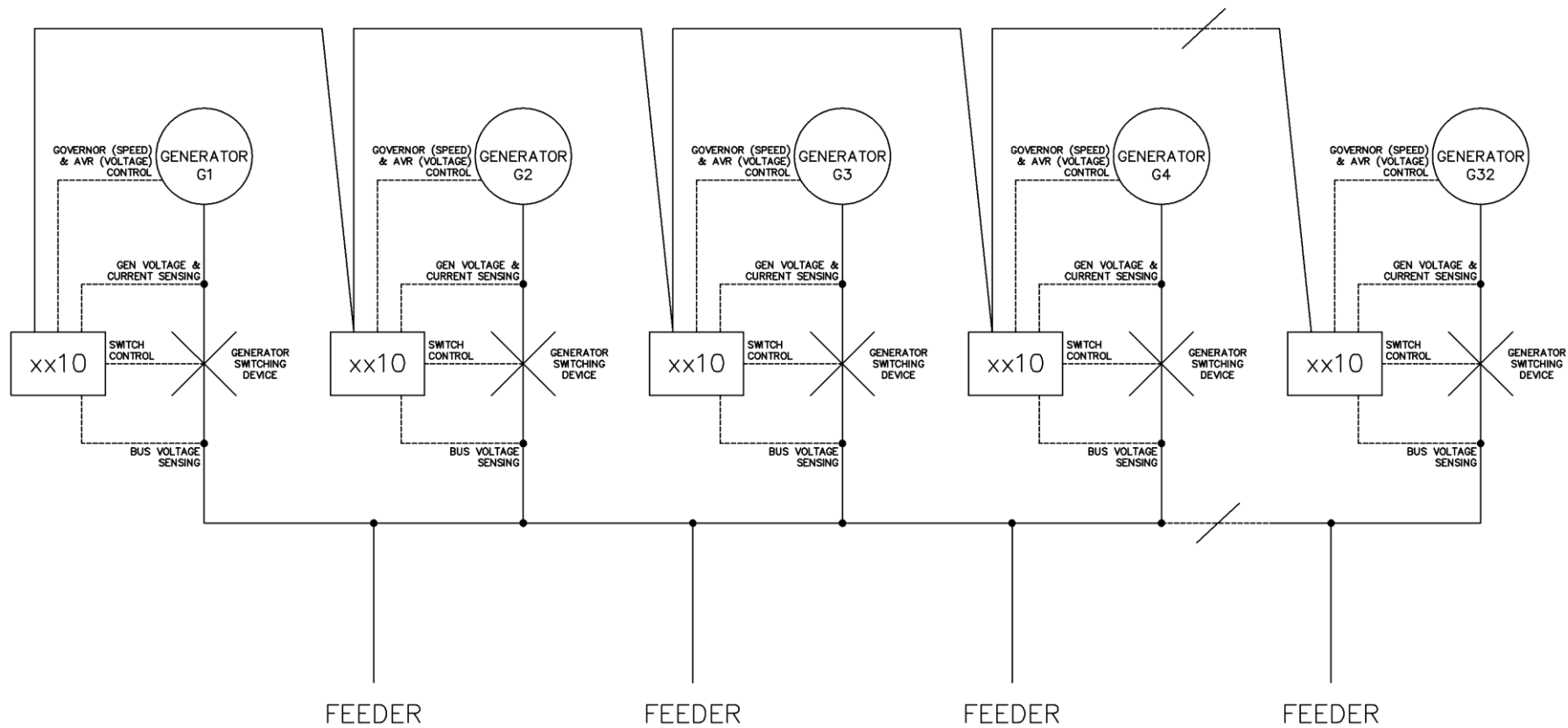

3.5.2 MULTI GENERATORS FOR PRIME POWER USING LOAD-SHARE LINES

NOTE: The below diagram is available in a larger scale. Contact DSE technical support for further information, support@deepseaelectronics.com.

NOTE: To use analogue loadshare lines from external *Load Share Units*, each DSE8x10 MKII must be fitted with a DSE123 to convert its MSC link. It is advised that the system is controlled by an external third party *Logic Controller* to provide automatic start/stop facilities and protections. For further information, refer to DSE Publication: 057-003 *DSE123 Operators Manual* or contact DSE technical support support@deepseaelectronics.com.

KW AND KVAR LOADSHARE LINE

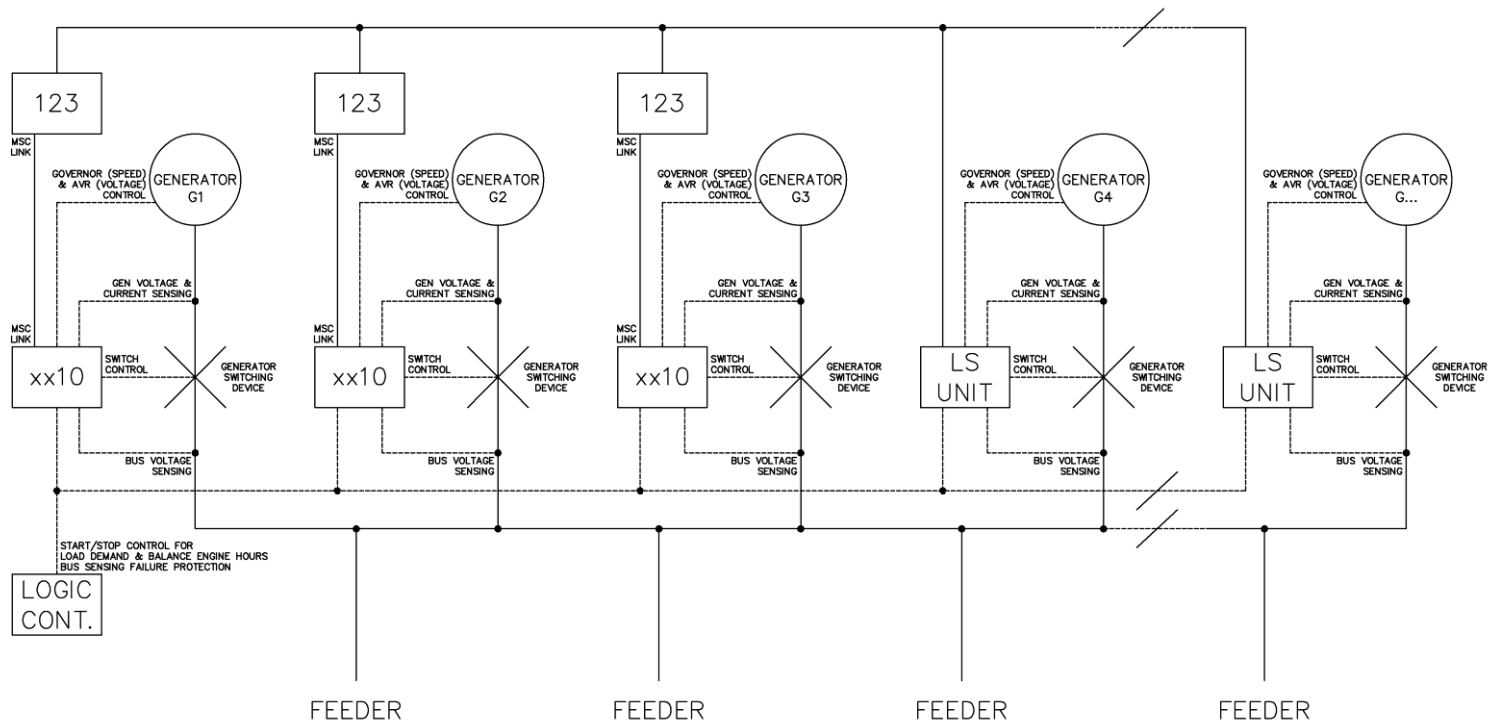

3.5.3 MULTI GENERATORS FOR PRIME POWER WITH BUS COUPLERS

NOTE: The below diagram is available in a larger scale. Contact DSE technical support for further information, support@deepseaelectronics.com.

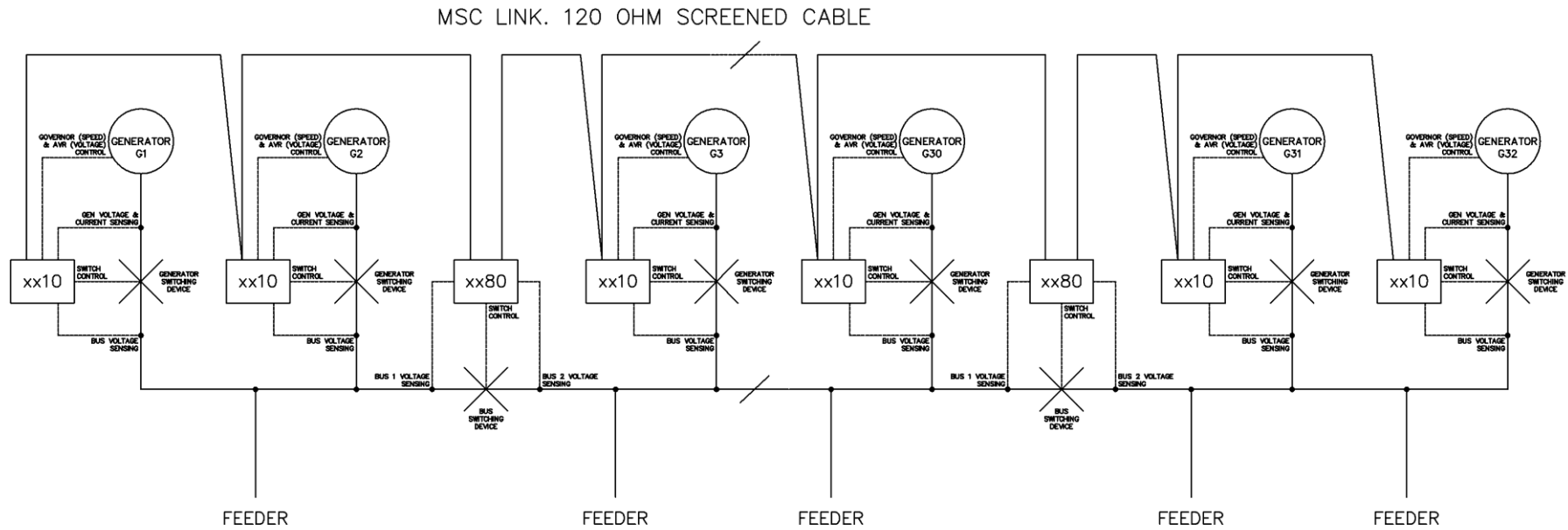

3.5.4 MULTI GENERATORS WITH SINGLE SYNCHRONISING MAINS SWITCH

NOTE: The below diagram is available in a larger scale. Contact DSE technical support for further information, support@deepseaelectronics.com.

NOTE: To use the DSE8x60 MKII without a bus breaker, the *No Bus Breaker* option in the DSE8x10 MKII and DSE8x60 MKII modules must be enabled. For further details of module configuration, refer to DSE Publication: 057-238 *DSE8610 MKII Configuration Suite PC Software Manual* and DSE Publication: 057-257 *DSE8660 MKII Configuration Suite PC Software Manual*, or contact DSE technical support for further information, support@deepseaelectronics.com.

NOTE: When the *No Bus Breaker* option is enabled, only one DSE8x60 MKII unit must be used in the system

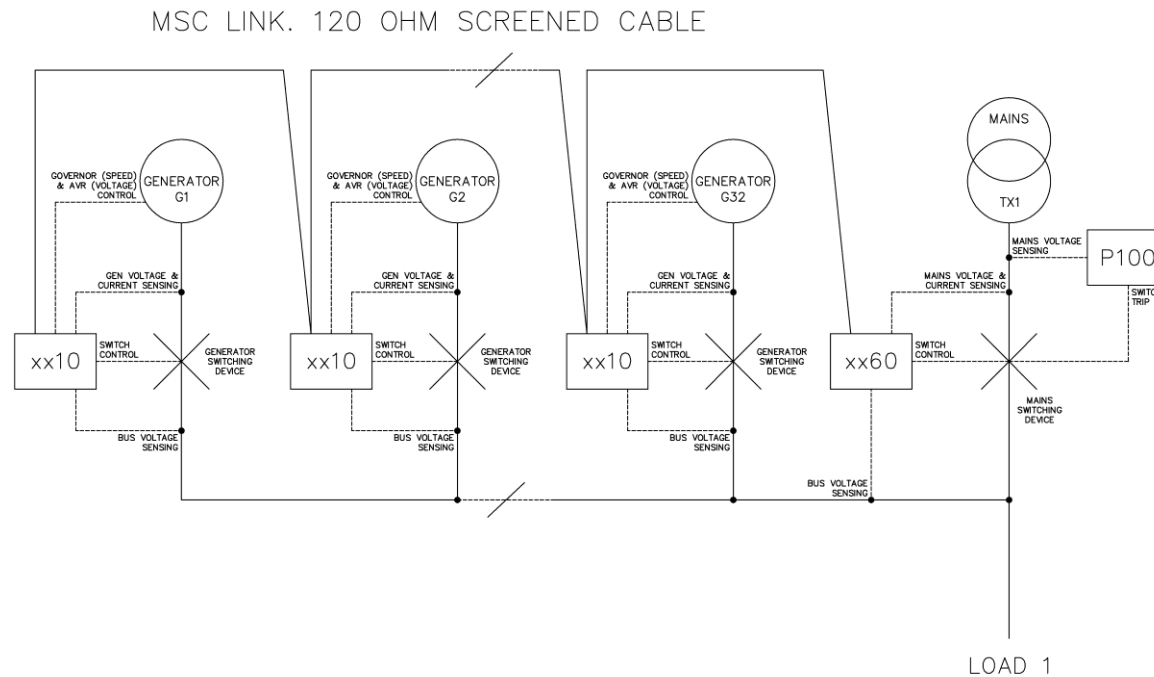

3.5.5 MULTI GENERATORS WITH SINGLE SYNCHRONISING TRANSFER SWITCH

NOTE: The below diagram is available in a larger scale. Contact DSE technical support for further information, support@deepseelectronics.com.

MSC LINK. 120 OHM SCREENED CABLE

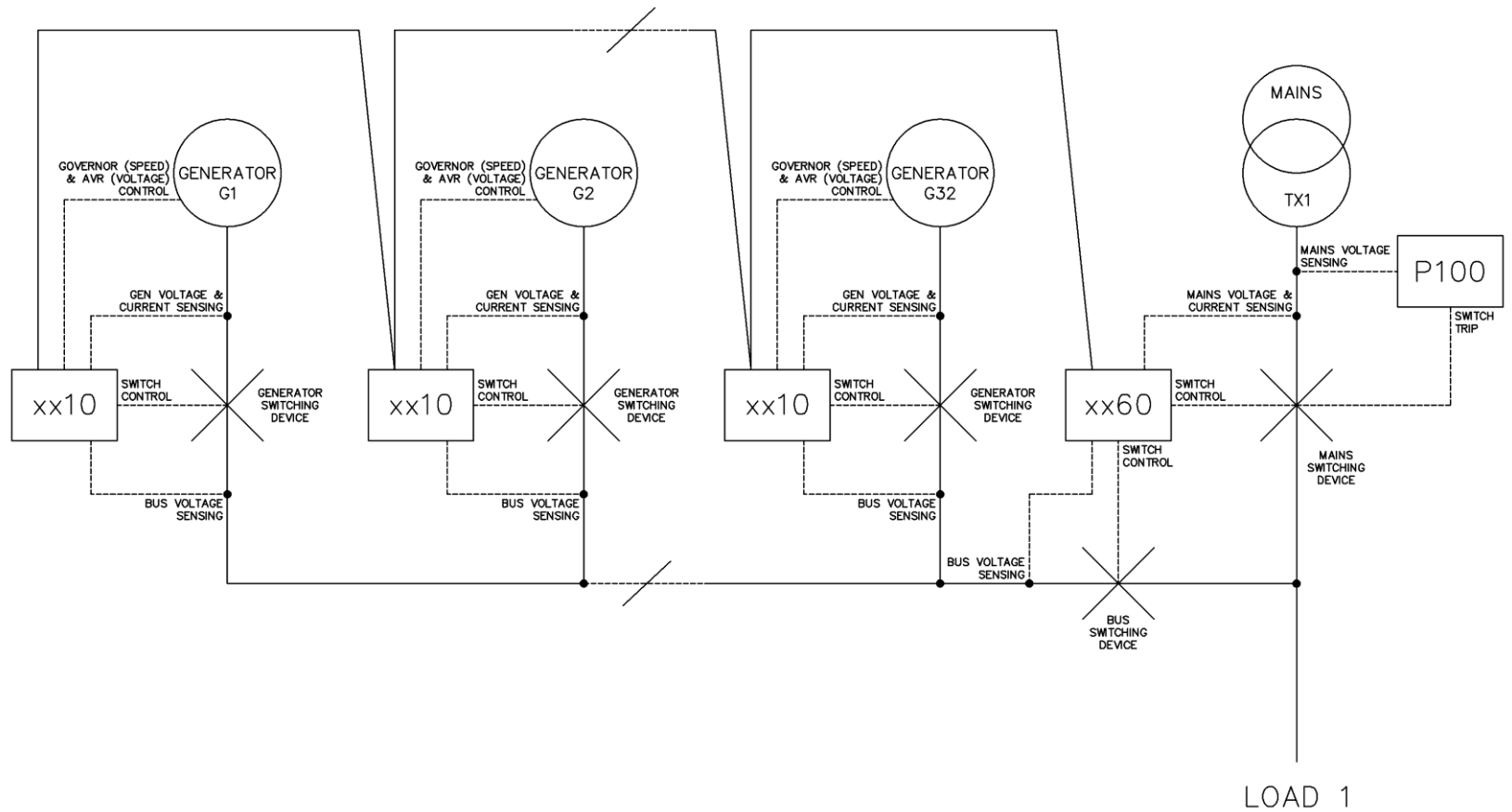

3.5.6 MULTI GENERATORS WITH TWO SYNCHRONISING TRANSFER SWITCHES

NOTE: The below diagram is available in a larger scale. Contact DSE technical support for further information, support@deepseaelectronics.com.

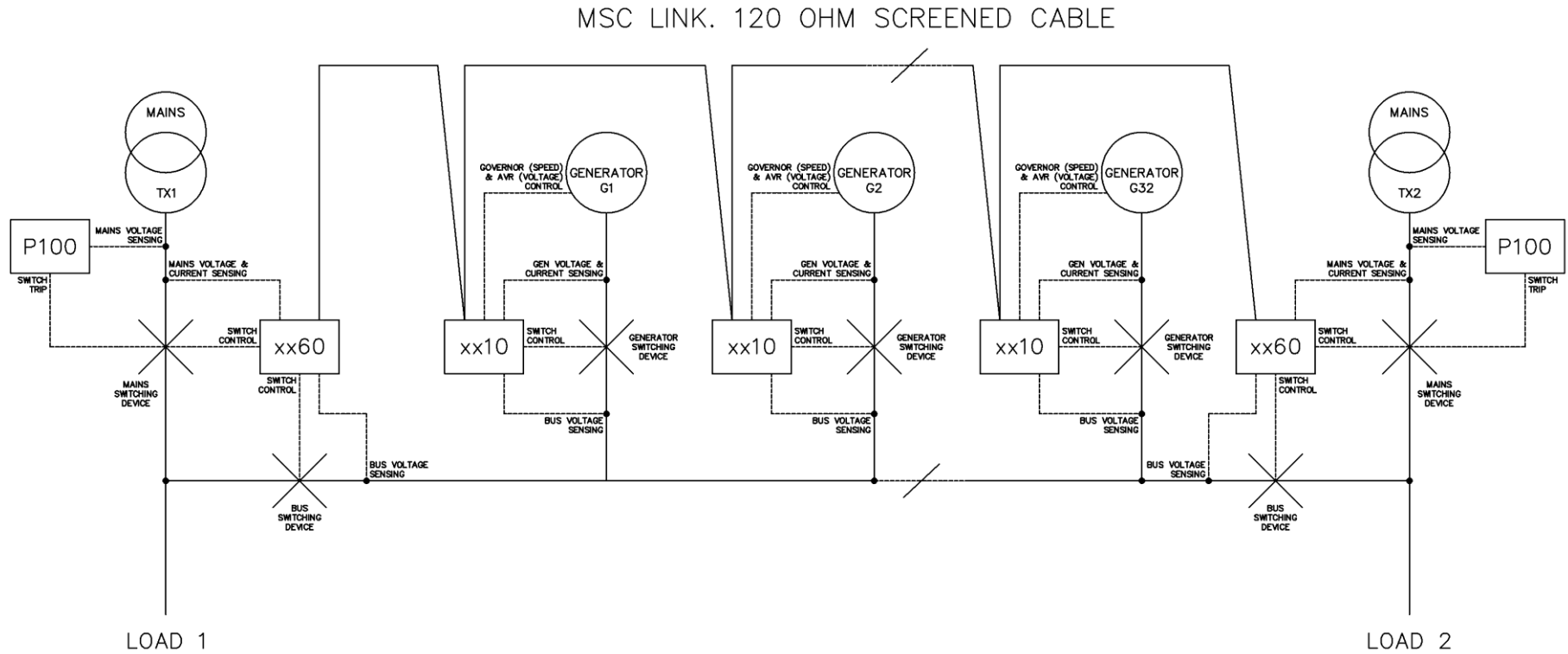

3.5.7 MULTI GENERATORS & SYNCHRONISING TRANSFER SWITCHES

NOTE: The below diagram is available in a larger scale. Contact DSE technical support for further information, support@deepseaelectronics.com.

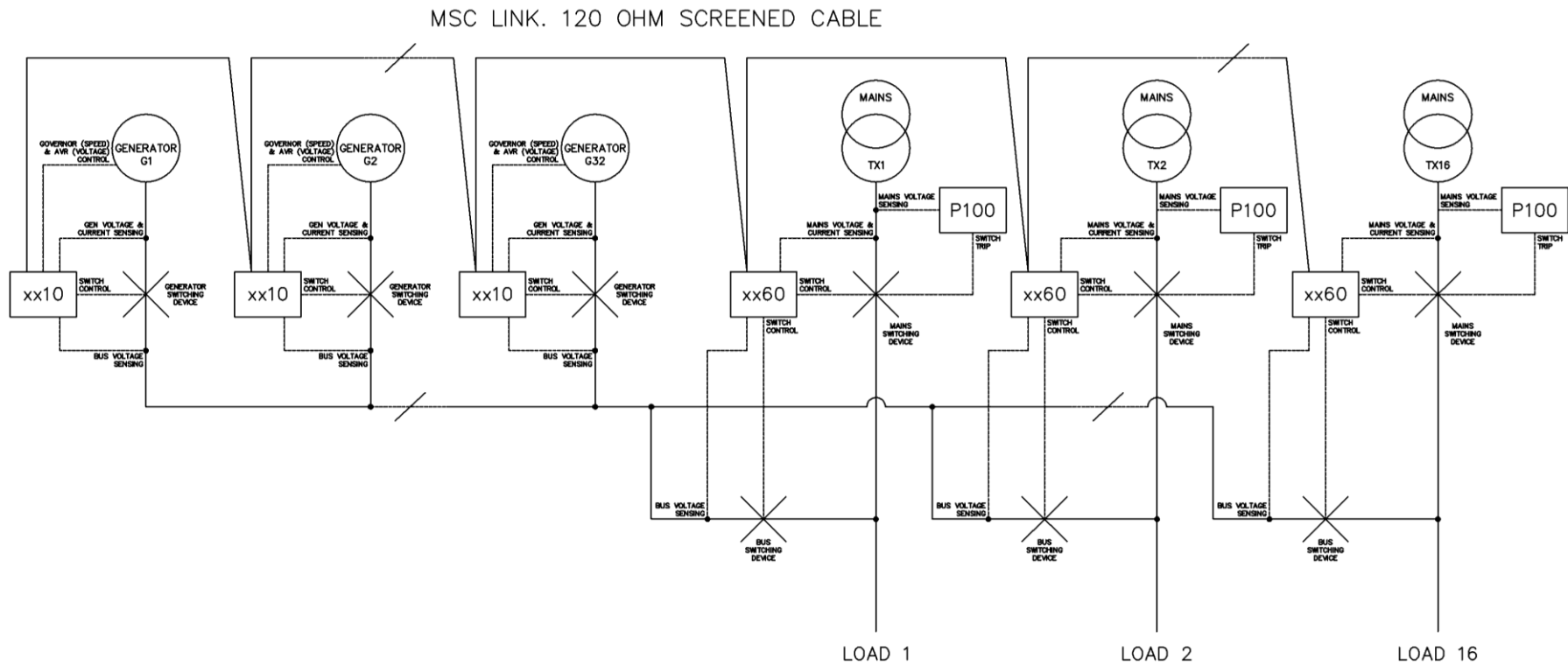

3.5.8 MULTI GENERATORS & TRANSFER SWITCHES WITH BUS COUPLER

NOTE: The below diagram is available in a larger scale. Contact DSE technical support for further information, support@deepseaelectronics.com.

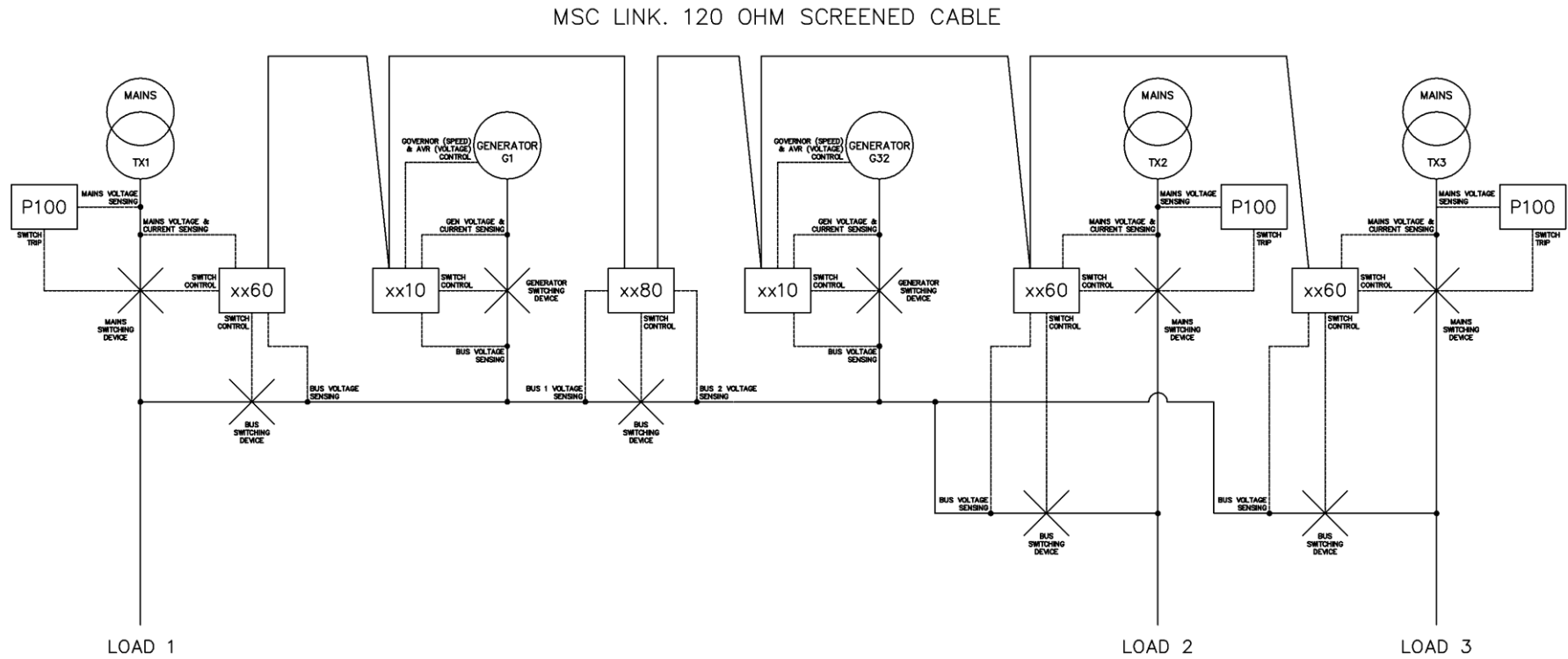

3.5.9 SINGLE GENERATOR EXPORTING (BASE LOADING) POWER

NOTE: When the DSE8x10 MKII unit is used for exporting (base loading) power it cannot be used for synchronising back to the mains upon its return without a DSE8x60 unit. For further details of export (base loading) power and its operation, refer to DSE Publication: 056-054 *DSExx10 in Fixed Export.*

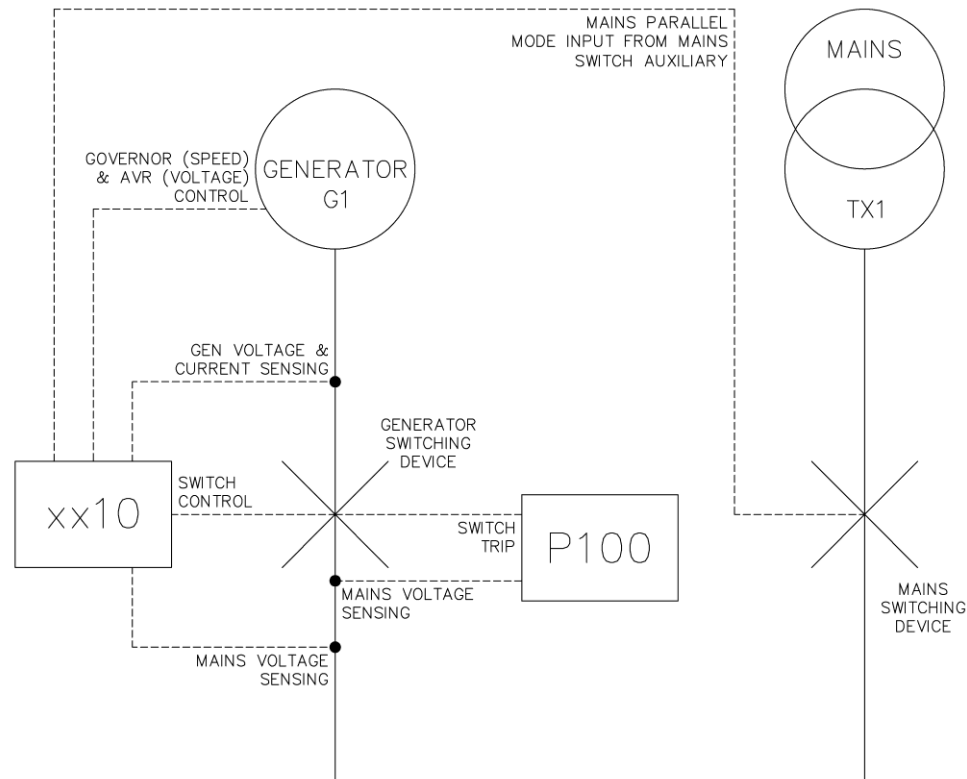

3.5.10 MULTI GENERATORS EXPORTING (BASE LOADING) POWER

NOTE: The below diagram is available in a larger scale. Contact DSE technical support for further information, support@deepseaelectronics.com.

NOTE: When the DSE8x10 MKII unit is used for exporting (base loading) power it cannot be used for synchronising back to the mains upon its return without a DSE8x60 unit. For further details of export (base loading) power and its operation, refer to DSE Publication: *056-054 DSExx10 in Fixed Export*.

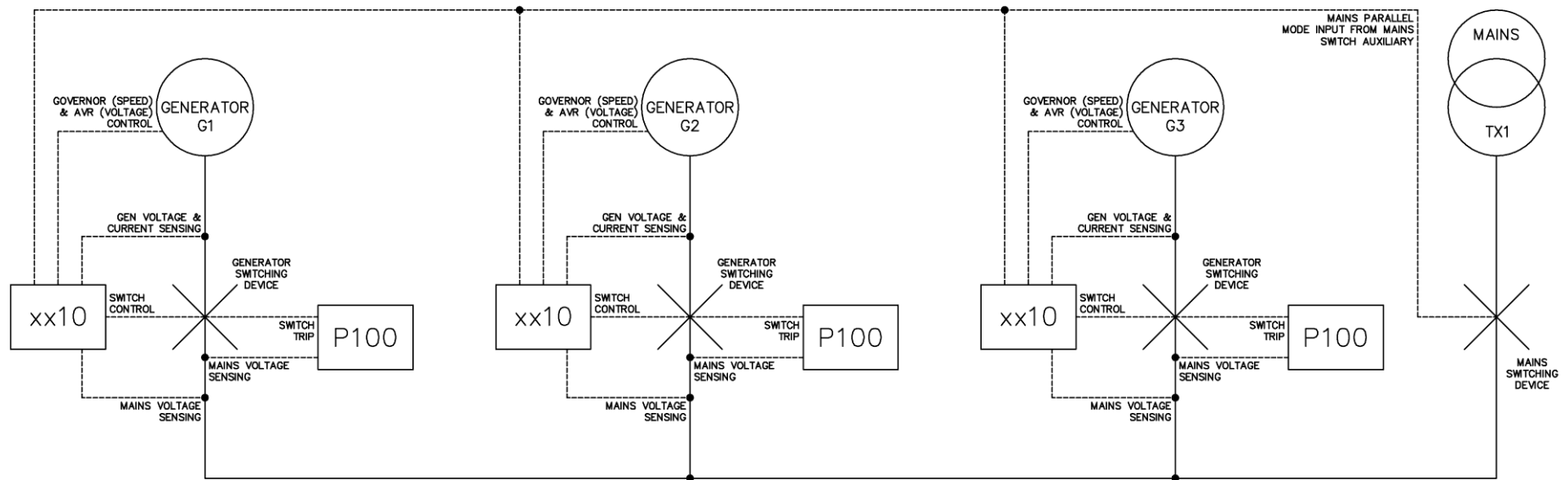

4 DESCRIPTION OF CONTROLS











CAUTION: The module may instruct an engine start event due to external influences. Therefore, it is possible for the engine to start at any time without warning. Prior to performing any maintenance on the system, it is recommended that steps are taken to remove the battery and isolate supplies.



NOTE: The following descriptions detail the sequences followed by a module containing the standard 'factory configuration'. Always refer to your configuration source for the exact sequences and timers observed by any particular module in the field.

Control of the module is via push buttons mounted on the front of the module with





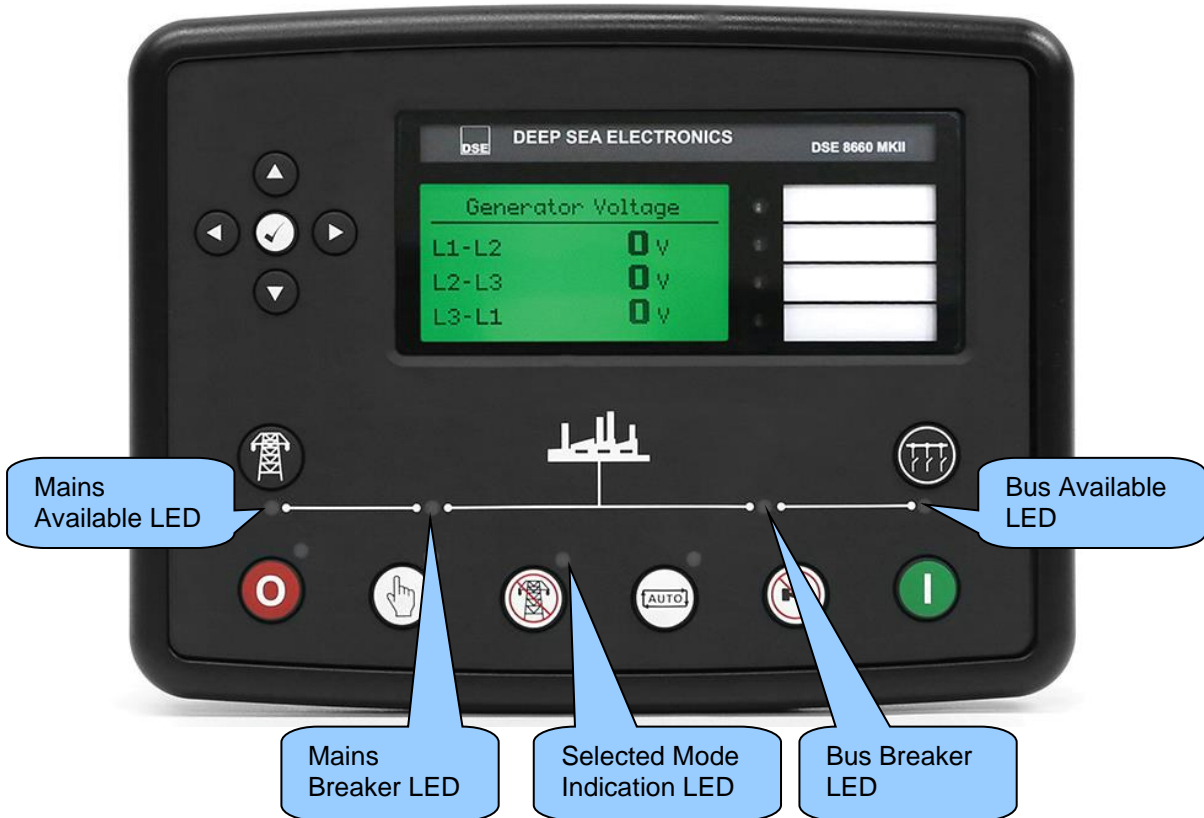
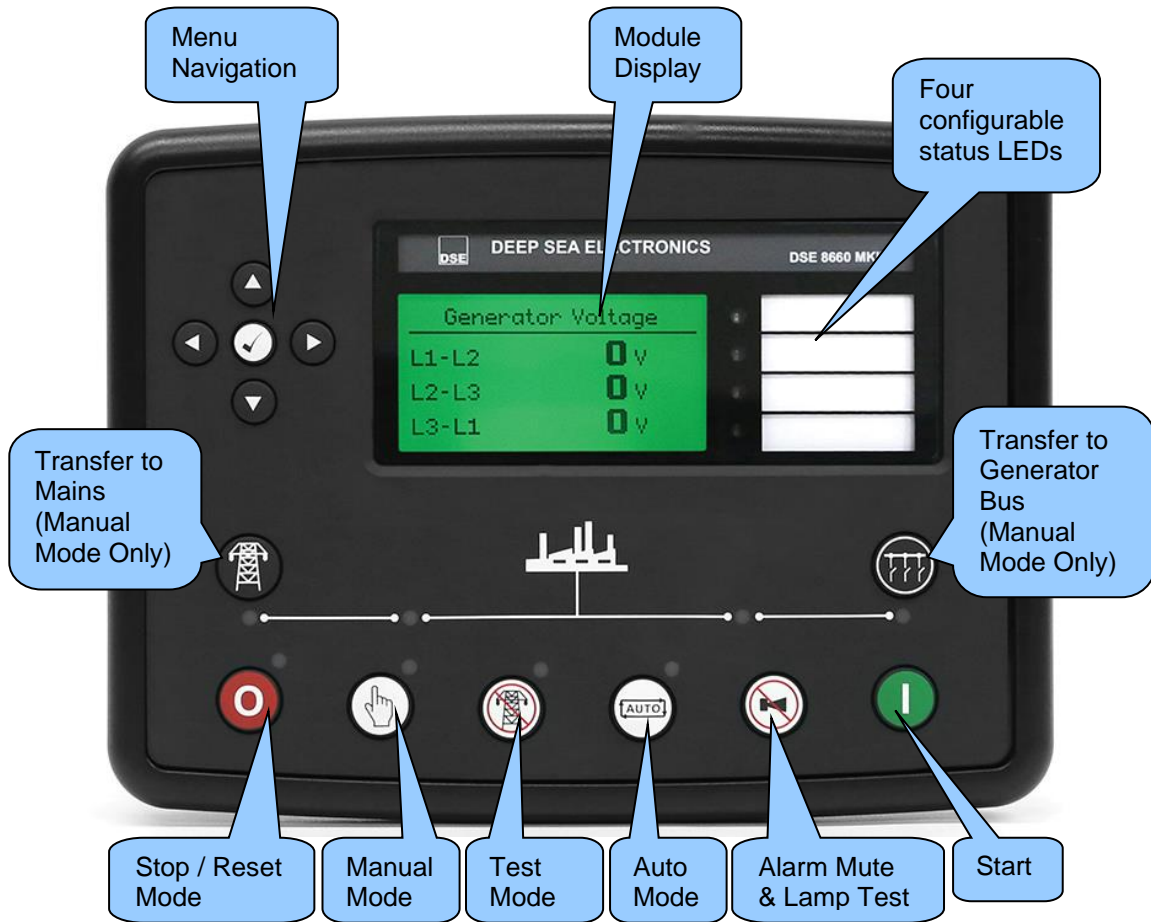













Stop/Reset Mode , **Manual Mode** , **Test Mode** , **Auto Mode** , **Alarm Mute/Lamp Test** , **Start** , **Transfer to Mains**  and **Transfer to Generator Bus**  functions. For normal operation, these are the only controls which need to be operated. Details of their operation are provided later in this document.

Description of Controls











4.1 CONTROL PUSH BUTTONS











 **NOTE:** For further details, see section entitled *Operation* elsewhere in this manual.

Icon	Description
	<p>Stop / Reset Mode</p> <p>This button places the module into its Stop/Reset Mode . This clears any alarm conditions for which the triggering criteria have been removed. If the generator is running on load and the module is put into Stop/Reset Mode , the module automatically opens the generator bus breaker ('Close Bus' becomes inactive) and instructs the DSE8x10 module to enter the return delay. Should any form of Remote Start Signal be present while operating in this mode, a start request to the DSE8x10 module over the MSC Link does <u>not</u> occur.</p>
	<p>Manual Mode</p> <p>This button places the module into its Manual Mode . Once in Manual Mode , the module responds to the Start  button to send a start request to the DSE8x10 module over the MSC Link. The module monitors the MSC Link for feedback from the DSE8x10 module to confirm the generator bus is available.</p> <p>If the generator bus is running off-load in the Manual Mode  and a Start Signal becomes active, the module automatically instructs the changeover device to place the generator bus on load ('Close Bus' becomes active), synchronising to the Mains if required. Upon removal of the Start On Load Signal, the generator bus remains on load until either the Stop/Reset Mode  or Auto Mode  is selected.</p> <p>Also in Manual Mode , the module responds to the Transfer to Mains  and Transfer to Generator Bus  buttons after the generator bus is available. Synchronising occurs automatically if required.</p>
	<p>Test Mode</p> <p>This button places the module into its Test Mode . Once in Test Mode , the module responds to the Start  button to send a start request to the DSE8x10 module over the MSC Link. The module monitors the MSC Link for feedback from the DSE8x10 module to confirm the generator bus is available.</p> <p>Once the generator bus is available, it is automatically placed on load ('Close Bus' becomes active), synchronising to the Mains if required. Depending upon module configuration, the generator bus remains in constant parallel with the Mains or proceeds to run in island operation ('Close Mains' becomes inactive).</p> <p>The generator bus remains on load until either the Stop/Reset Mode  or Auto Mode  is selected.</p>











 **NOTE:** For further details, see section entitled *Operation* elsewhere in this manual.

Icon	Description
	<p>Auto Mode</p> <p>This button places the module into its Auto Mode . This mode allows the module to control the function of the system automatically. The module monitors various Start Signals and once a start request is made, sends a start request to the DSE8x10 module over the MSC Link. The module monitors the MSC Link for feedback from the DSE8x10 module to confirm the generator bus is available.</p> <p>Once the generator bus is available and if requested, it is automatically placed on load ('Close Bus' becomes active), synchronising to the Mains if required. Upon removal of the Start On Load Signal, the module starts the <i>Return Delay Timer</i> and once expired, the generator bus is taken off load ('Close Bus' becomes inactive). The module then waits for next start event.</p>
	<p>Alarm Mute / Lamp Test</p> <p>This button de-activates the audible alarm on the module, the <i>Audible Alarm</i> output (if configured) and illuminates all of the LEDs on the module's fascia.</p>
	<p>Start</p> <p>This button is only active in Manual Mode .</p> <p>Pressing the Start  button in Manual Mode  sends a start request to the DSE8x10 module over the MSC Link.</p>
	<p>Navigation Keys</p> <p>Used for navigating the instrumentation, event log and configuration screens.</p>

 **NOTE:** For further details, see section entitled 'Operation' elsewhere in this manual.

Icon	Description
	<p>Transfer to Mains</p> <p>The Transfer to Mains  button control the operation of the mains load switching and is only active in Manual Mode  once the generator bus is available.</p> <p>'Normal' Breaker Button Control</p> <ul style="list-style-type: none"> • Synchronising NOT Enabled: Pressing the Transfer to Mains  button when the Mains is available and off load, the generator bus load switch is opened ('Close Bus' becomes inactive) and the mains load switch is closed ('Close Mains' becomes active). Further presses of the Transfer to Mains  button have no effect. • Synchronising Enabled: Pressing the Transfer to Mains  button when the Mains is available and off load, the module synchronise the Generator Bus to the Mains. The mains load switch is then closed in parallel with the Generator Bus ('Close Mains' & 'Close Bus' are active). Further presses of the Transfer to Mains  button ramps the entire load from the Generator Bus to the Mains. Once done, the Generator Bus load switch opens ('Close Bus' becomes inactive) leaving just the mains supplying the load. <p>'Alternative' Breaker Button Control</p> <ul style="list-style-type: none"> • Synchronising NOT Enabled: Pressing the Transfer to Mains  button when the Mains is available and off load, the generator bus load switch is opened ('Close Bus' becomes inactive) and the mains load switch is closed ('Close Mains' becomes active). Further presses of the Transfer to Mains  button opens and closes the mains load switch ('Close Mains' changes state) and leaves the bus load switch in the open position ('Close Bus' remains inactive). • Synchronising is enabled: Pressing the Transfer to Mains  button when the Mains is available and off load, the module synchronise the Generator Bus to the Mains. The mains load switch is then closed in parallel with the Generator Bus ('Close Mains' & 'Close Bus' are active). Further presses of the Transfer to Mains  button ramps the entire load from the Mains to the Generator Bus. Once done, the Mains load switch opens ('Close Mains' becomes inactive) leaving just the Generator Bus supplying the load.

 **NOTE:** For further details, see section entitled 'Operation' elsewhere in this manual.

Icon	Description
	<p>Transfer to Generator Bus</p> <p>The Transfer to Generator Bus  button control the operation of the mains load switching and is only active in Manual Mode  once the generator bus is available.</p> <p>'Normal' Breaker Button Control</p> <ul style="list-style-type: none"> • Synchronising NOT Enabled: Pressing the Transfer to Generator Bus  button when the Generator Bus is available and off load, the Mains load switch is opened ('Close Mains' becomes inactive) and the Generator Bus load switch is closed ('Close Bus' becomes active). Further presses of the Transfer to Generator Bus  button have no effect. • Synchronising Enabled: Pressing the Transfer to Generator Bus  button when the Generator Bus is available and off load, the module synchronise the Generator Bus to the Mains. The Generator Bus load switch is then closed in parallel with the Mains ('Close Mains' & 'Close Bus' are active). Further presses of the Transfer to Generator Bus  button ramps the entire load from the Mains to the Generator Bus. Once done, the Mains load switch opens ('Close Mains' becomes inactive) leaving just the Generator Bus supplying the load. <p>'Alternative' Breaker Button Control</p> <ul style="list-style-type: none"> • Synchronising NOT Enabled: Pressing the Transfer to Generator Bus  button when the Generator Bus is available and off load, the Mains load switch is opened ('Close Mains' becomes inactive) and the Generator Bus load switch is closed ('Close Bus' becomes active). Further presses of the Transfer to Generator Bus  button opens and closes the Generator Bus load switch ('Close Bus' changes state) and leaves the Mains load switch in the open position ('Close Mains' remains inactive). • Synchronising Enabled: Pressing the Transfer to Generator Bus  button when the Generator Bus is available and off load, the module synchronise the Generator Bus to the Mains. The Generator Bus load switch is then closed in parallel with the Mains ('Close Mains' & 'Close Bus' are active). Further presses of the Transfer to Generator Bus  button ramps the entire load from the Generator Bus to the Mains. Once done, the Generator Bus load switch opens ('Close Bus' becomes inactive) leaving just the Mains supplying the load.

4.2 VIEWING THE INSTRUMENT PAGES

It is possible to scroll to display the different pages of information by repeatedly operating the

Next & Previous Page  buttons.

To view one of the instrument pages towards the end of the list, it may be quicker to scroll left through the pages rather than right!

Example

Status  Mains  Load  Further presses of the **Next Page Button** returns the display to the Status page.

The complete order and contents of each information page are given in the following sections

Once selected, the page remains on the LCD display until the user selects a different page, or after an extended period of inactivity (*LCD Page Timer*), the module reverts to the status display.

If no buttons are pressed upon entering an instrumentation page, the instruments displayed are automatically subject to the setting of the *LCD Scroll Timer*.

The *LCD Page* and *LCD Scroll* timers are configurable using the DSE Configuration Suite Software or by using the Front Panel Editor.

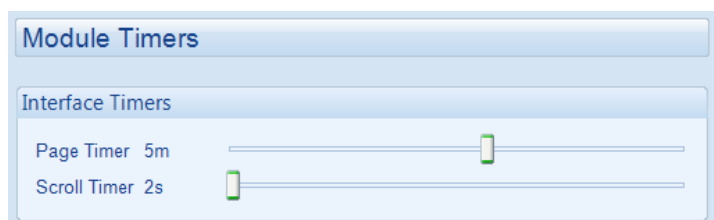

The screenshot shows the factory settings for the timers, taken from the DSE Configuration Suite Software.

Alternatively, to scroll manually through all instruments on the currently selected page, press the

Instrumentation Scroll  buttons. The 'auto scroll' is disabled.



To view one of the instruments towards the end of the list, it may be quicker to scroll up through the instruments rather than down!

To re-enable 'auto scroll' press the **Instrumentation Scroll**  buttons to scroll to the 'title' of the instrumentation page (ie Mains). A short time later (the duration of the *LCD Scroll Timer*), the instrumentation display begins to auto scroll.

When scrolling manually, the display automatically returns to the Status page if no buttons are pressed for the duration of the configurable *LCD Page Timer*.

If an alarm becomes active while viewing the status page, the display shows the Alarms page to draw the operator's attention to the alarm condition.

4.2.1 STATUS

 **NOTE:** Press the *Instrumentation Scroll*  buttons on the *Status Page* to view other Configurable Status Screens if configured. For further details of module configuration, refer to DSE Publication: *057-257 DSE8660 MKII Configuration Suite Software Manual*.

This is the 'home' page, the page that is displayed when no other page has been selected, and the page that is automatically displayed after a period of inactivity (*LCD Page Timer*) of the module control buttons.

This page changes with the action of the controller for example when the generator bus start request is given:

Status	22:31	Factory setting of Status screen showing no start request...
Mains On Load		
Auto Mode		

Status	22:31	...and generator bus available
Start Request		
Auto Mode		

4.2.1.1 ELECTRICAL TRIP

Status	22:31	<i>Electrical Trip</i> indicates that a start request cannot be given due to an active <i>Electrical Trip</i> alarm on the module.
Electrical Trip		
Stop Mode		

Press the *Next or Previous Page*  button to scroll to the alarms pages to investigate. Press the **Stop/Reset Mode**  button to clear the alarm, if the alarm does not clear, the fault is still active.

4.2.1.2 WAITING FOR CONTROL

 **NOTE:** For further details of module configuration, refer to DSE Publication: *057-257 DSE8660 MKII Configuration Suite Software Manual*.

Status	22:31	<i>Waiting For Control</i> indicates that the DSE8660 MKII is requesting to take control of the DSE8610 MKII units on the MSC but cannot due to another DSE8660 MKII having control. The other DSE8660 MKII releases control of the DSE8610 MKII units when they are no longer in parallel with the mains.
Waiting For Control		
Auto Mode		

4.2.1.3 CONFIGURABLE STATUS SCREENS

The contents of the Home Page may vary depending upon configuration by the generator manufacturer or supplier. Below is an example of the Home Page being changed to show Mains related information.

The screenshot shows a configuration interface titled "Configurable Status Screens". It has two main sections: "Home Page" and "Displayed Pages".

- Home Page:** A dropdown menu labeled "Home Page" with "Mode" selected. A callout bubble points to this dropdown, stating: "The configured status pages are displayed as the Home Page".
- Displayed Pages:** A table with 10 rows and 2 columns. The first row is "Page 1" with "Mains kW" selected. A callout bubble points to this row, stating: "Example of Mains kW being selected to be the default Home Page." The other rows are "Page 2" through "Page 10", all with "Not Used" selected. A second callout bubble points to the "Not Used" options, stating: "Other pages can be configured to be shown, automatically scrolling when the set is running."

Mains kW Home Screen Example:

Mains Load	
L1	201 kW
L2	190 kW
L3	195 kW

4.2.2 MAINS

Contains electrical values of the mains (utility), measured or derived from the module's (that controls the mains (utility) switch) voltage and current inputs.



Press the **Instrumentation Scroll** buttons scroll through the **Mains** parameters.

- Mains Voltage (ph-N)
- Mains Voltage (ph-ph)
- Mains Frequency
- Mains Current
- Mains Load (kW)
- Mains Total Load % (kW)
- Mains Load (kV A)
- Mains Total Load % (kV A)
- Mains Power Factor
- Mains Average Power Factor
- Mains Load (kV Ar)
- Mains Total Load % (kV Ar)
- Mains Load (kW h, kV A h, kV Ar h)
- Mains Phase Sequence
- Mains Config
- ROCOF (ROCOF & Vector Shift)
- Sequence Voltage (Zero, Positive, Negative)
- Voltage Asymmetry
- Synchroscope
- Battery Voltage

4.2.2.2 SYNCHROSCOPE OPERATION

▲ Note: If the module display is showing the status page when the synchronising process begins, the module automatically switches to the Synchroscope page. The ramp progress will also be displayed on the screen once paralleling has taken place.

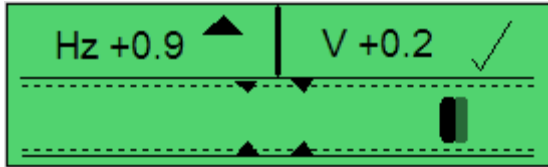

Initially the synchroscope display shows the difference between the mains and generator bus supplies. Here the display is showing a frequency mismatch of +0.9 Hz and a voltage mismatch of +0.2 V. The generator bus frequency is too high (indicated by the arrow) and must be reduced. The voltage is high, but is within the limits set for synchronising (indicated by the tick).

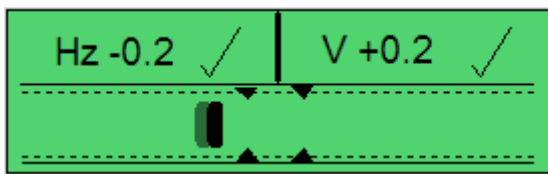

When both the frequency and the voltage differences are within acceptable limits, the phase matching begins. Then the moving bar shows the phase difference between the two supplies. The bus frequency is automatically adjusted, altering the phase, until the moving bar enters the centre of the scope.

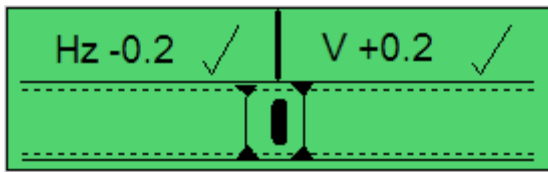

Once the mains and generator bus supplies are in sync, the module initiates a breaker close signal to the bus load switch closing the bus onto the mains. If synchronism is broken the moving bar will pass out of the synchronising window and the Out of Sync alarm activates. .

4.2.3 BUS

Contains electrical values of the bus, measured or derived from the module's (that controls the generator bus switch) voltage input and MSC link.



Press the **Instrumentation Scroll** buttons scroll through the **Bus** parameters.

- Bus Voltage (ph-N)
- Bus Voltage (ph-ph)
- Bus Frequency
- Bus Total Load % (kW)
- Bus Total Load % (kVAr)
- Bus Phase Sequence
- Load (Current, Power Factor)
- Load (kW, kVA, kVAr)
- Sequence Voltage (Zero, Positive, Negative)
- Voltage Asymmetry
- Commissioning Page 1
- Commissioning Page 2
- Commissioning Page 3
- Commissioning Page 4
- MSC Connected 8610

4.2.3.1 COMMISSIONING SCREENS

 **NOTE: Some of the items are removed from the commissioning screens if they are not applicable to the module configuration.**

Commissioning screens are available to both aid the commissioning process and also to give additional information about the synchronising and load sharing process. These screens are enabled and disabled in the module's display editor.

Commissioning Screen 1

L – L	0 V	kW	0.0	Mains average L-L V and total kW
Sets Ld	0	kVAr	0.0	Sets on load and total kvar
Ramp	0.0%	kW	0.0%	Ramp rate and percentage of full load kW
Pf	----	kVAr	0.0%	Power factor and percentage of full load kW

Commissioning Screen 2

kW	0	kVAr	0	Actual kW and actual kVAr
BTgt	0%	kW	0.0%	Bus target kW and actual kW percentage
BTgt	0%	kVAr	0.0%	Bus target kVAr and actual kVAr percentage
Sets Ld	0	BV12	0V	Sets on load and bus average L1-L2 V

Commissioning Screen 3

MTgt	0%	kW	0.0	Mains target kW and actual kW
BTgt	0%	kVAr	0.0	Bus target kVAr and actual kVAr
Pf	----	L-L	0V	Power factor and mains average L-L V
Sets Ld	0	Amps	0A	Sets on Load and load average current

Commissioning Screen 4

NVb	0V	NVm	0V	Nominal voltage bus and nominal voltage mains
AD	0V	NAD	0V	Average difference and nominal average difference
MV12	0V	BV12	0V	Mains average L1-L2 V and bus average L1-L2 V
SM12	0V	Pha	0°	Scaled mains voltage L1-L2 V and phase angle

4.2.3.2 DSE8X10 MSC CONNECTION STATUS

NOTE: The *MSC ID* is configured only using the DSE Configuration Suite Software. For further details, refer to DSE Publication: 057-257 *DSE8660 MKII Configuration Suite PC Software Manual*.

NOTE: Depending on the module's configuration, the *MSC ID* is set automatically or manually. For further details, refer to DSE Publication: 057-257 *DSE8660 MKII Configuration Suite PC Software Manual*.

Every module connected on the MSC link has a unique *MSC ID*.

The *MSC ID* is set automatically or manually depending on the *Disable Auto ID Allocation* option in the DSE module's configuration.

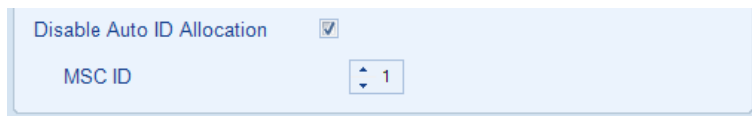

When the *Disable Auto ID Allocation* option is not enabled in the DSE module's configuration, the *MSC ID* is automatically set when all the modules are powered up one at a time. If all the modules are powered up together, this may result in the *MSC ID Error* alarm activating.

Manually setting the *MSC ID* using the DSE Configuration Suite PC Software's SCADA allows this alarm to be reset and prevents this from occurring. It also has the benefit of being able to determine which module on the MSC link has a communication issue.

When the *Disable Auto ID Allocation* option is enabled in the DSE module's configuration, the *MSC ID* is assigned to the configured *MSC ID* value when the module is powered up. Take note to enable this option in all the DSE modules if to be used, ensuring that each DSE module has a unique *MSC ID*.

This display screen shows this module's *MSC ID* and shows which *MSC IDs* are currently communicating on the MSC link by the number 1 indication. *MSC IDs* that are currently not communicating or not connected are indicated by the number 0. If the *MSC ID* for each module is known, this display screen can be used to determine which module is not communicating on the MSC link. The shaded numbers indicate the generators on load. The small numbers (32 & 1) on the top-left and bottom-right of the screen represent the *MSC ID* orders.

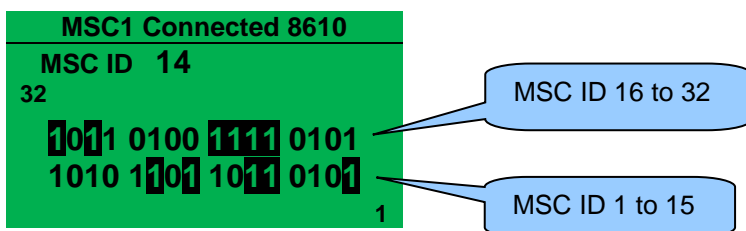

4.2.4 EXPANSION

 **NOTE: For further details of module configuration, refer to DSE Publication: 057-257 DSE8660 MKII Configuration Suite Software Manual.**

Contains measured values from various input expansion modules that are connected to the DSE module.



Press the **Instrumentation Scroll** buttons scroll through the **Expansion** parameters if configured.

- DSE2130 Analogue Inputs (Only appears if configured)
- DSE2131 Analogue Inputs (Only appears if configured)
- DSE2133 Analogue Inputs (Only appears if configured)

4.2.5 CHARGER ID

NOTE: Depending upon the module's configuration, some display screens may be disabled. For further details of module configuration, refer to DSE Publication: *057-257 DSE8660 MKII Configuration Suite Software Manual*.

Contains the information and instrumentation of the DSE Intelligent Battery Chargers that are connected to the DSE controller.

Press the **Instrumentation Scroll**  buttons scroll through the **Battery Charger** parameters if configured.

Charger ID1		Shows the ID number configured in the DSE module's Expansion
Device	94xx V1.1.1	Information screen of the charger connected to the DSE module (battery charger model number, version, and its USB ID).
USB ID	1E1F21EA	
Supply Voltage		
L1 - N	240V	Supply Instrumentation Screen.
Charger ID1		
Temperature	32 °C 89 °F	Battery charger temperature instrumentation screen.
Charger ID1		
Fan 1	100 rpm	Battery charger fans speed when supported by the charger.
Fan 2	0 rpm	
Charger Output 1		
Charge Mode	Float	Output Instrumentation screens. Showing Output 1 of the battery charger.
Charger Output 1		
Output	26.91V	Showing the charge mode (Boost, Absorption, Float, or Storage)
Charger Output 1		
Current	7.05A	... Output voltage
Limit	10.00A	
Power	189W	
Charger Output 1		
Current	7.05A	...Output current, limit, and power
Limit	10.00A	
Power	189W	

4.2.6 ALARMS

When an alarm is active, the *Internal Audible Alarm* sounds and the Common Alarm LED, if configured, illuminates.

The audible alarm is silenced by pressing the **Alarm Mute / Lamp Test**  button.

The LCD display jumps from the 'Information page' to display the Alarm Page

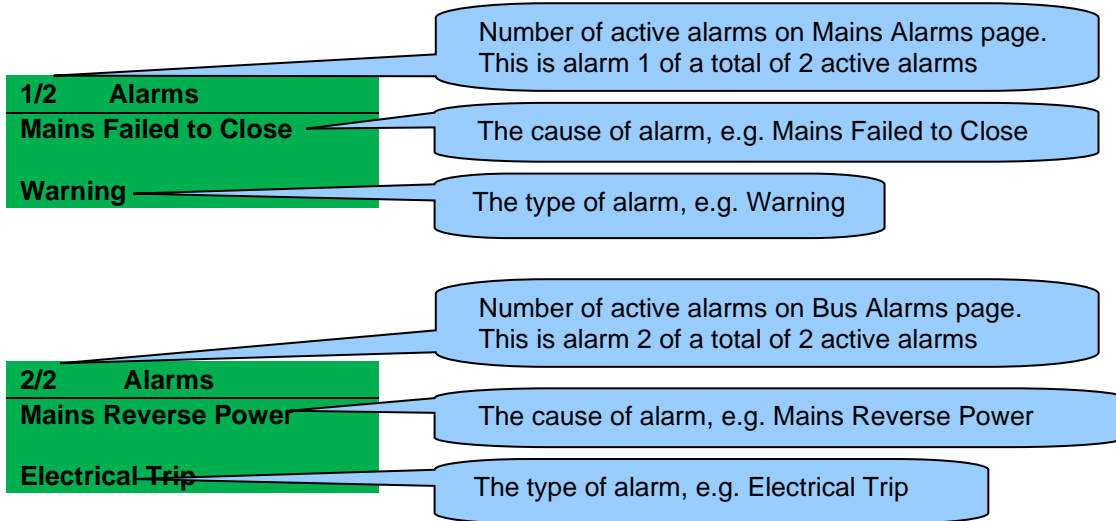

The LCD displays multiple alarms such as "*Mains Failed to Close*" and "*Mains Reverse Power*". These automatically scroll in the order that they occurred.

In the event of an alarm, the LCD displays the appropriate text. If an additional alarm then occurs, the module displays the appropriate text.

Example:

1/2 Alarms
Mains Failed to Close
Warning

2/2 Alarms
Mains Reverse Power
Electrical Trip

4.2.7 EVENT LOG

The module maintains a log of past alarms and/or selected status changes. At the time of writing, the modules log is capable of storing the last 250 log entries.

Under default factory settings, the event log is configured to include all possible options; however, this is configurable by the system designer using the DSE Configuration Suite software.

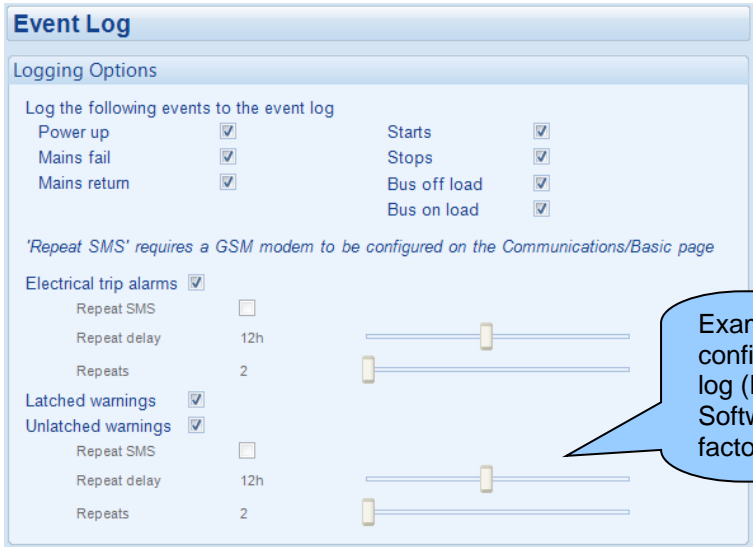

When the event log is full, any subsequent event overwrites the oldest entry. Hence, the event log always contains the most recent events. The module logs the event type, along with the date and time. If the module is configured and connected to a modem, an SMS message is sent on any logged event.

To view the event log, repeatedly press the **Next or Previous Page**  buttons until the LCD screen displays the *Event Log* page.

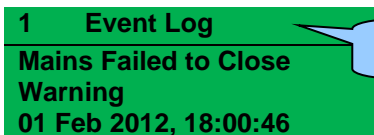

This is event 1

Press the **Scroll Down**  button to view the next most recent event.

Continuing to press the **Scroll Down**  button cycles through the past events after which, the display shows the most recent alarm and the cycle begins again.

To exit the event log and return to viewing the instruments, press the **Next or Previous Page**  buttons to select the next instrumentation page.

4.2.8 COMMUNICATIONS

4.2.8.1 RS232 SERIAL PORT

NOTE: Factory default settings are for the RS232 port to be enabled for *Gencomm* connection, operating at 115200 baud, MODBUS slave address 10.

NOTE: Connecting a modem directly to the module's RS232 is for legacy support only. When a new installation requires remote communication using the cellular network, refer to DSE products DSE890, DSE891 and DSEWebNet on the DSE website: www.deepseaelectronics.com.

This section is included to give information about the RS232 serial port and external modem (if connected).

The items displayed on this page change depending upon configuration of the module. Refer to the system supplier for further details.

Connected To an RS232 Telephone Modem

When the module is powered up, it sends 'initialisation strings' to the connected modem. It is important therefore that the modem is already powered, or is powered up at the same time as the module. At regular intervals after power up, the modem is reset, and reinitialised, to ensure the modem does not 'hang up'.

If the module does not correctly communicate with the modem, "Modem initialising" appears on the Serial Port instrument screen as shown overleaf.

If the module is set for "incoming calls" or for "incoming and outgoing calls", once the modem is dialled, it answers after two rings (using the factory setting 'initialisation strings'). Once the call is established, all data is passed between the dialling PC and the module.

If the module is set for "outgoing calls" or for "incoming and outgoing calls", then the module dials out whenever an alarm is generated.

NOTE: Not all alarms generate a dial out command; this is dependant upon module configuration of the event log. Any event configured to be recorded in the event log causes the modem to dial out to a PC.

Serial Port	
Baud	9600
SlaveID	10
Modem	

Press the **Scroll Down**  button view the modem status....

Indicates that the RS232 port is configured for modem use. It displays 'RS232' if no modem is configured.

Connected to an RS232 GSM Modem

NOTE: Not all alarms generate a dial out command; this is dependant upon module configuration of the event log. Any event configured to be recorded in the event log causes the modem to dial out to a PC.

NOTE: In the case of GSM modems, it is important that a **DATA ENABLED SIM** is used. This is often a different number than the 'voice number' and is often called **Circuit Switched Data (CSD)** by the SIM provider.

When the module is powered up, it sends 'initialisation strings' to the connected modem. It is important therefore that the modem is already powered, or is powered up at the same time as the module. At regular intervals after power up, the modem is reset, and reinitialised, to ensure the modem does not 'hang up'.

If the module does not correctly communicate with the modem, "Modem initialising" appears on the Serial Port instrument screen as shown overleaf.

If the module is set for "incoming calls" or for "incoming and outgoing calls", once the modem is dialled, it answers after two rings (using the factory setting 'initialisation strings'). Once the call is established, all data is passed between the dialling PC and the module.

If the module is set for "outgoing calls" or for "incoming and outgoing calls", then the module dials out whenever an alarm is generated.

Many GSM modems are fitted with a status LED to show operator cell status and ringing indicator. These are a useful troubleshooting tool.

In the case of GSM connection problems, try calling the DATA number of the SIMCARD with an ordinary telephone. There should be two rings, followed by the modem answering the call and then 'squealing'. If this does not happen, check all modem connections and double check with the SIM provider that it is a DATA SIM and can operate as a data modem. DATA is NOT the same as FAX or GPRS and is often called Circuit Switched Data (CSD) by the SIM provider.

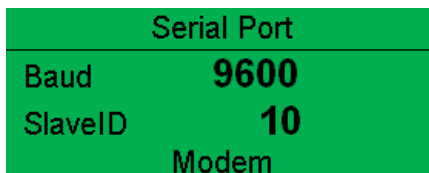

Press the **Scroll Down**  button view the modem GSM status....

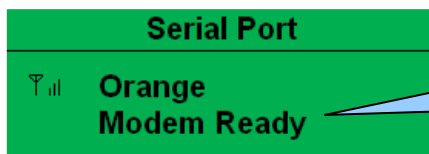

Currently connected GSM operator and signal strength.

If the GSM modem is not purchased from DSE, ensure that it has been correctly set to operate at 9600 baud.

Modem Initialisation Sequence

The modem attempts to communicate to the module

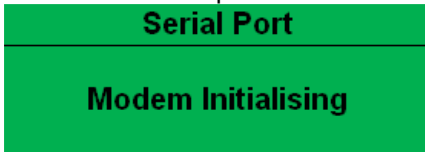

If the Modem and module communicate successfully:

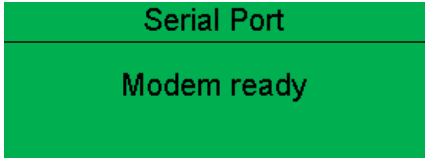

In case of communication failure between the modem and module, the modem is automatically reset and initialisation is attempted once more:

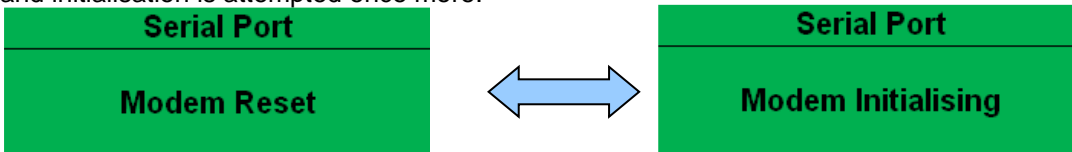

In the case of a module that is unable to communicate with the modem, the display continuously cycles between 'Modem Reset' and 'Modem Initialising' as the module resets the modem and attempts to communicate with it again, this continues until correct communication is established with the modem. In this instance, check connections and verify the modem operation.

Modem Diagnostics

Modem diagnostic screens are included; press the **Scroll Down**  button when viewing the *RS232 Serial Port* instruments to cycle to the available screens. If experiencing modem communication problems, this information aids troubleshooting.

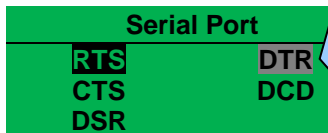

Shows the state of the modem communication lines. These can help diagnose connection problems.
 Example:
RTS A dark background shows the line is active.
RTS A grey background shows that the line is toggling high and low
RTS No background indicates that the line is inactive

Line	Description	
RTS	Request to Send	Flow Control
CTS	Clear to Send	Flow Control
DSR	Data Set Ready	Ready to Communicate
DTR	Data Terminal Ready	Ready to Communicate
DCD	Data Carrier Detect	Modem is Connected

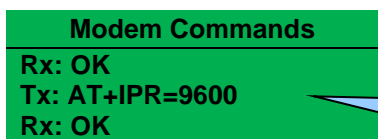

Shows the last command sent to the modem and the result of the command.

Connected to An RS232 MODBUS Master

The modules operate as a MODBUS RTU slave device. In a MODBUS system, there is only one Master, typically a PLC, HMI system, PC SCADA system, or another DSE module using its *PLC Comms*.

This master requests for information from the MODBUS slave (The module) and may (in control systems) also send request to change operating modes etc. Unless the Master makes a request, the slave is 'quiet' on the data link.

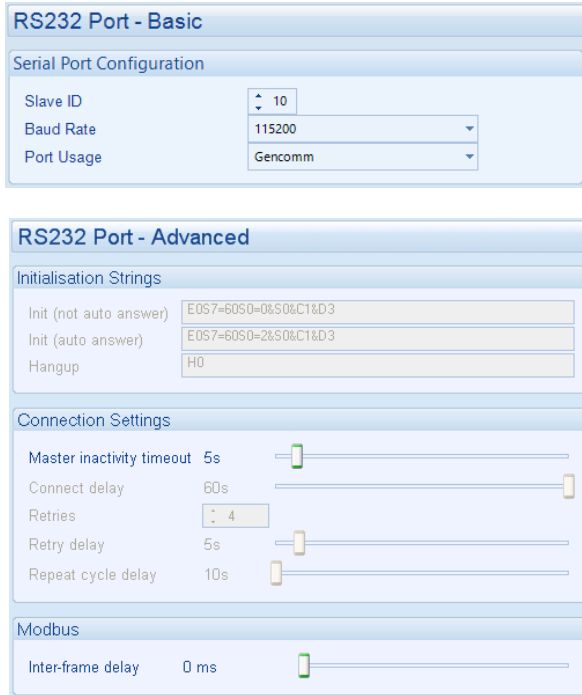

The factory settings are for the module to communicate at 115200 baud, MODBUS slave address 10.

To use the RS232 port, ensure that 'port usage' is correctly set using the DSE Configuration Suite Software.

'Master inactivity timeout' should be set to at least twice the value of the system scan time. For example if a MODBUS master PLC requests data from the module once per second, the timeout should be set to at least 2 seconds

The DSE MODBUS document containing register mappings inside the DSE module is available upon request from support@deepseaelectronics.com. Email the request along with the serial number of the DSE module to ensure the correct information is sent.

RS232 MODBUS RTU Diagnostics

RS232 MODBUS RTU diagnostic screens are included; press the **Scroll Down**  button when viewing the *RS232 Serial Port* instruments to cycle to the available screens. If experiencing RS232 MODBUS RTU communication problems, this information aids troubleshooting.

RS232	
Link Quality	98 %
RX Rate	49
Lost Rate	1

Shows the state of the RS232 communication lines. These can help diagnose connection problems.

Link Quality: The quality of the RS232 connection
RX Rate: The number of received message during the packet timeout
Lost Rate: The number of messages that are discarded (invalid messages)

Connected to An RS232 Slave DSE Module

NOTE: For details on how to use the *PLC* to read from another DSE module's GenComm registers, refer to DSE Publication: *057-314 Advanced PLC Software Manual* which is found on our website: www.deepseaelectronics.com

The module operates as a master controller to read from another DSE module's GenComm registers. In a MODBUS system, there is only one Master, therefore ensure the other DSE module's *RS232 Port Usage* is configured to *Gencomm* to act as a slave and respond to the master DSE module's queries as specified in its PLC. For further details see section entitled *RS232 Used For PLC Communication* elsewhere in this document.

Serial Port	
Baud	115200
Slave ID	10
RS232 PLC Master	

Showing the DSE module's RS232 Port configured to *PLC*

The DSE module's PLC requests certain information that are defined as Gencomm registers to read from the MODBUS slave module. The DSE module then uses the read information to perform certain functions which are configured in its PLC Editor.

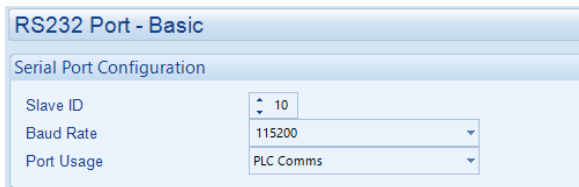

The factory settings are for the module to communicate at 115200 baud, MODBUS slave address 10.

To use the RS232 port to read from another DSE module, ensure that 'port usage' is correctly set using the DSE Configuration Suite Software.

4.2.8.2 RS485 SERIAL PORT

NOTE: Factory default settings are for the RS485 port to be enabled for *Gencomm* connection, operating at 115200 baud, MODBUS slave address 10.

This section is included to give information about the currently selected serial port

The items displayed on this page change depending upon configuration of the module. Refer to the system supplier for further details.

Connected to an R485 MODBUS Master

NOTE: The MODBUS Master can be another DSE module communicating through its PLC. For further details see section entitled *RS485 Used For PLC Communication* elsewhere in this document.

The modules operate as a MODBUS RTU slave device. In a MODBUS system, there is only one Master, typically a PLC, HMI system, PC SCADA system, or another DSE module using its PLC Comms.

Serial Port	
Baud	19200
SlaveID	1
RS485	

This master requests for information from the MODBUS slave (The module) and may (in control systems) also send request to change operating modes etc. Unless the Master makes a request, the slave is 'quiet' on the data link.

The factory settings are for the module to communicate at 115200 baud, MODBUS slave address 10.

'Master inactivity timeout' should be set to at least twice the value of the system scan time. For example if a MODBUS master PLC requests data from the module once per second, the timeout should be set to at least 2 seconds.

The screenshot shows a configuration window titled "RS485 Ports" with a sub-section for "RS485 Port 1". The settings are as follows:

Slave ID	10
Baud Rate	115200
Port Usage	Gencomm
Master inactivity timeout	5s
Inter-frame delay	0 ms

The DSE MODBUS document containing register mappings inside the DSE module is available upon request from support@deepseaelectronics.com. Email the request along with the serial number of the DSE module to ensure the correct information is sent.

RS485 MODBUS RTU Diagnostics



RS485 MODBUS RTU diagnostic screens are included; press the **Scroll Down** button when viewing the *RS485 Serial Port* instruments to cycle to the available screens. If experiencing RS485 MODBUS RTU communication problems, this information aids troubleshooting.

RS485 Port 1	
Link Quality	50 %
RX Rate	25
Lost Rate	25

Shows the state of the RS485 communication lines. These can help diagnose connection problems.

Link Quality: The quality of the RS485 connection
RX Rate: The number of received message during the packet timeout
Lost Rate: The number of messages that are discarded (invalid messages)

Typical Requests (Using Pseudo Code)

BatteryVoltage=ReadRegister(10,0405,1): reads register (hex) 0405 as a single register (battery volts) from slave address 10.

WriteRegister(10,1008,2,35701, 65535-35701): Puts the module into AUTO mode by writing to (hex) register 1008, the values 35701 (auto mode) and register 1009 the value 65535-35701 (the bitwise opposite of auto mode)

Warning=(ReadRegister(10,0306,1) >> 11) & 1): reads (hex) 0306 and looks at bit 12 (Warning alarm present)

ElectricalTrip=(ReadRegister(10,0306,1) >> 10) & 1): reads (hex) 0306 and looks at bit 11 (Electrical Trip alarm present)

ControlMode=ReadRegister(10,0304,2): reads (hex) register 0304 (control mode).

Connected to RS485 Slave DSE Modules

NOTE: For details on how to use the *PLC* to read from another DSE module's GenComm registers, refer to DSE Publication: *057-314 Advanced PLC Software Manual* which is found on our website: www.deepseaelectronics.com

The module operates as a master controller to read from other DSE module(s) GenComm registers. In a MODBUS system, there is only one Master, therefore make sure the other DSE module's *RS485 Port Usage* is configured to *Gencomm* to act as a slave and respond to the master DSE module's queries as specified in its PLC. For further details see section entitled *RS485 Used For PLC Communication* elsewhere in this document.

Serial Port

Baud **115200**
 Slave ID **10**
RS485 PLC Master

Showing the DSE module's RS485 Port configured to *PLC*

The DSE module's PLC requests certain information that are defined as Gencomm registers to read from the MODBUS slave module. The DSE module then uses the read information to perform certain functions which are configured in its PLC Editor.

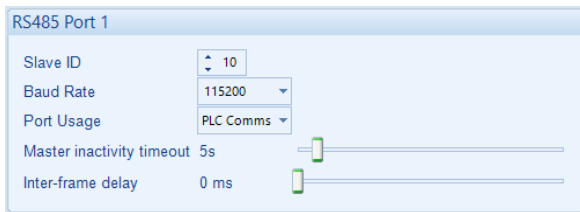

The factory settings are for the module to communicate at 115200 baud, MODBUS slave address 10.

To use the RS485 port to read from another DSE module, ensure that 'port usage' is correctly set using the DSE Configuration Suite Software.

4.2.8.3 USB CONNECTION

Whilst in the *Communication* section, press the **Scroll Down**  button to access more information about the USB Slave Connection status.

USB Connection

Connected

Connected/Inactive: Indicates the connection status of the USB Slave Connection which is normally used for module configuration.

4.2.8.4 ETHERNET

Whilst in the *Communication* section, press the **Scroll Down**  button to access more information about the network settings.

Network settings are configured using DSE Configuration Suite PC Software. The module must be rebooted for the changes to take effect.

Network	
IP Address	192.168.50.76
DHCP	Disabled

IP Address: The configured network IP address of the module
DHCP: Dynamic Host Configuration Protocol (DHCP) has been enabled or disabled in the modules configuration.

Press the **Scroll Down**  button to access more information about the network settings.

Network	
Subnet Mask	255.255.255.0

Subnet Mask: The configured network subnet mask of the module.

Network	
Gateway Address	192.168.49.76

Gateway Address: The configured network gateway address of the module.

Network	
DNS Address	192.168.88.99

DNS Address: The configured network DNS address of the module.

Network	
MAC Address	E8.A4.C1.0.A.C2

MAC Address: The MAC address of the module, this cannot be changed and is unique to every Ethernet device.

DHCP	
Host Name	
Domain Name	
Vender Name	

DHCP: The DHCP settings of module if configured.

MODBUS Over IP	
TCP Port	502
Pref IP	192.168.20.11

TCP Port: The MODBUS TCP communication port number.
Pref IP: The preferred connection IP address. The module can support up to 5 MODBUS TCP masters. If the preferred IP address is configured, one of those five connections is reserved for the device with the preferred IP.

Ethernet Connection 0	
	192.168.50.77
	Connected

Ethernet Connection #: State of the 5 individual Ethernet connections
IP Address: IP address of the device connected via Ethernet.
Connected/Inactive: State of the port connection

4.2.8.5 DSENET CONNECTION



DSENet diagnostic screens are included; press the **Scroll Down** button when viewing the *Communication* instrument section to cycle to the available screen. If experiencing DSENet communication problems, this information aids troubleshooting.

DSENet Connection	
Link Quality	75 %
RX Rate	200
Lost Rate	50

Shows the state of the DSENet communication lines. These can help diagnose connection problems.

Link Quality: The quality of the DSENet connection
RX Rate: The number of received message during the packet timeout
Lost Rate: The number of messages that are discarded (invalid messages)

4.2.8.6 MSC CONNECTION



MSC diagnostic screens are included; press the **Scroll Down** button when viewing the *Communication* instrument section to cycle to the available screen. If experiencing MSC communication problems, this information aids troubleshooting.

MSC 1 Connection	
Link Quality	75 %

Shows the state of the MSC communication lines. These can help diagnose connection problems.

MSC # Connection: State of the standard (1) or redundant (2) MSC connections.
Link Quality: The quality of the MSC connection

4.2.9 SCHEDULE

NOTE: For further details on the operation of the inbuilt scheduler feature, refer to section entitled *Scheduler* in the *Operation* section of this document.

NOTE: For further details of module configuration, refer to DSE Publication: *057-257 DSE8660 MKII Configuration Suite Software Manual*.

The controller contains an inbuilt exercise run scheduler, capable of automatically starting and stopping the set or inhibiting the set from starting. Up to 16 scheduled (in two banks of 8) start/stop/inhibiting start sequences can be configured to repeat on a 7-day or 28-day cycle.

Scheduled runs may be on load or off load depending upon module configuration.

This section of the module's display shows how exactly the scheduler (if enabled) is configured. Under default factory settings the Schedule is not viewable. It is enabled by the system designer using the DSE Configuration Suite software.

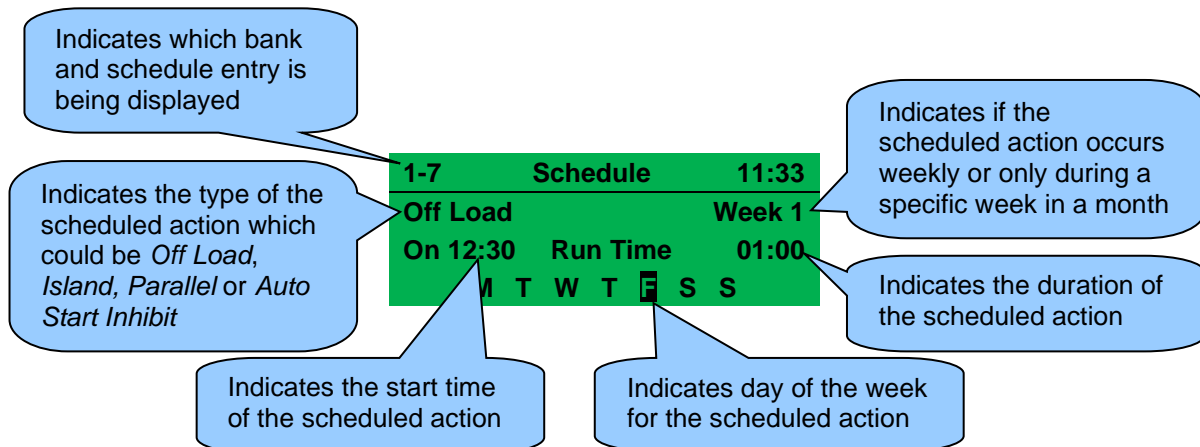

4.2.10 EDITOR

NOTE: Depending upon the module's configuration, some display screens may be disabled. For further details of module configuration, refer to DSE Publication: *057-257 DSE8660 MKII Configuration Suite Software Manual*.

Contains a selection of parameters selected by the system integrator that may be edited from the facia without having to enter the module's *Front Panel Editor* (no PIN required).

Press the **Instrumentation Scroll**  buttons scroll through the **Editor** parameters if configured.

4.2.11 PLC INSTRUMENTS

NOTE: Depending upon the module's configuration, some display screens may be disabled. For further details of module configuration, refer to DSE Publication: *057-257 DSE8660 MKII Configuration Suite Software Manual* and *057-314 Advanced PLC Programming Guide for DSE Controllers*.

Contains values from various elements from the module's internal PLC editor to enable the user to view them from the module's fascia.

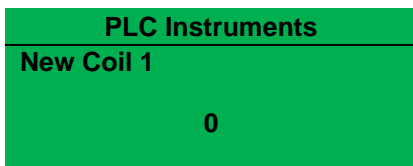

Press the **Instrumentation Scroll**  buttons scroll through the **PLC Instruments** parameters if configured.

Coil Example:



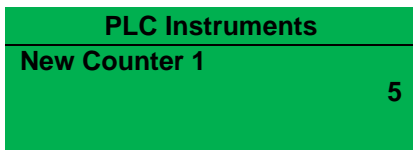

Counter Example:



Counter 1: The name of the Counter as configured in the PLC.
Value: The value the Counter currently contains. This value can be edited from the fascia by pressing and holding the **Tick**  **and then using the Instrumentation Scroll**  button to change the value.

Persistent Variable Example:



Persistent Variable: The name of the Persistent Variable as configured in the PLC.
Value: The value the Persistent Variable currently contains. This value can be edited from the fascia by pressing and holding the **Tick**  **and then using the Instrumentation Scroll**  button to change the value.



String Example:

PLC Instruments	
New String Var 1	Test

String: The name of the string as configured in the PLC.
Value: The initial value text as configured in the PLC.

Timer Example:

PLC Instruments	
New Timer 1	00:00:02.5

Timer 1: The name of the timer as configured in the PLC.
Value: The time configured in the PLC. This value can be edited from the fascia by pressing and holding the **Tick**  **and then using the Instrumentation**  **Scroll**  button to change the value.

Variable Example:

PLC Instruments	
New Variable 1	58

Variable: The name of the Variable as configured in the PLC.
Value: The value the Variable currently contains.

Delay On Timer Example:

PLC Instruments	
TON – 1	
Actual	00:14:07
Set Point	00:50:30

TON – 1: The name of the Delay On Timer as configured in the PLC.
Actual: The time the timer has currently reached.
Set Point: The time at which the timer stops incrementing

Delay Off Timer Example:

PLC Instruments	
TOF – 2	
Actual	00:17:01
Set Point	00:41:30

TOF – 2: The name of the Delay Off Timer as configured in the PLC.
Actual: The time the timer has currently reached.
Set Point: The time at which the timer stops incrementing

Counter Example:

PLC Instruments	
Counter 1	
Actual	5
Set Point	15

Counter 1: The name of the counter as configured in the PLC.
Actual: The number the counter has currently reached.
Set Point: The number at which the counter stops incrementing

4.2.12 MISCELLANEOUS

4.2.12.1 DATA LOGGING

Whilst in the 'ABOUT' section, press **Scroll Down**  button to access more information about the data logging settings.

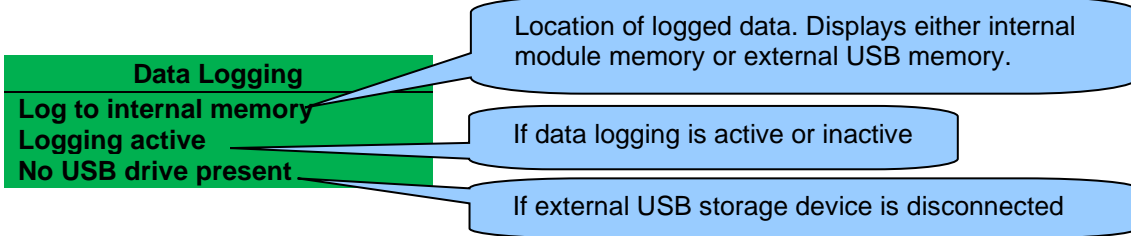

The screenshot shows the 'Data Logging' screen with the following text: 'Data Logging', 'Log to internal memory', 'Logging active', and 'No USB drive present'. Callouts explain: 'Log to internal memory' is the location of logged data; 'Logging active' indicates if data logging is active or inactive; 'No USB drive present' indicates if an external USB storage device is disconnected.

Inserting a USB storage device to the USB host connector on the rear of the module displays the following change to the page.

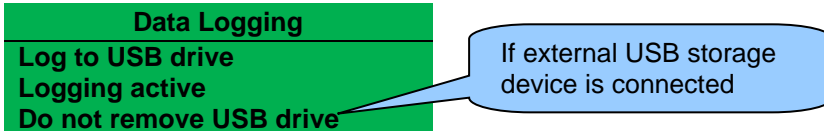

The screenshot shows the 'Data Logging' screen with the following text: 'Data Logging', 'Log to USB drive', 'Logging active', and 'Do not remove USB drive'. A callout explains that 'Do not remove USB drive' indicates an external USB storage device is connected.

Press **Scroll Down**  button to view the next page.

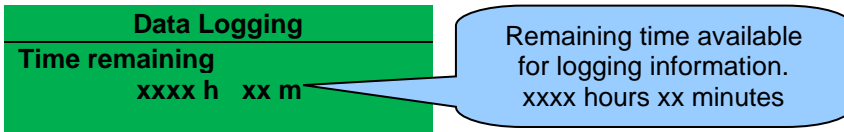

The screenshot shows the 'Data Logging' screen with the following text: 'Data Logging', 'Time remaining', and 'xxxx h xx m'. A callout explains that 'Time remaining' shows the remaining time available for logging information in 'xxxx hours xx minutes'.

Press **Scroll Down**  button to view the next page.

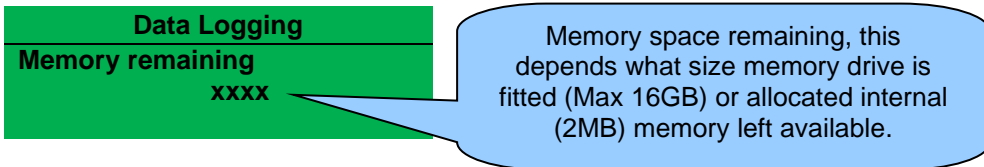

The screenshot shows the 'Data Logging' screen with the following text: 'Data Logging', 'Memory remaining', and 'xxxx'. A callout explains that 'Memory remaining' shows the memory space remaining, depending on whether a memory drive is fitted (Max 16GB) or allocated internal (2MB) memory left available.

USB Eject Procedure

 **NOTE:** Removal of the USB memory device **MUST** only be carried out using the following method whilst viewing the Data Logging Status screen.

Press and hold the **Tick**  button until "Ok to remove USB drive" is displayed.

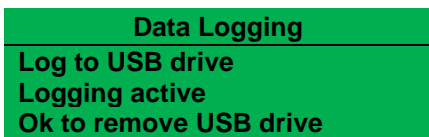

The screenshot shows the 'Data Logging' screen with the following text: 'Data Logging', 'Log to USB drive', 'Logging active', and 'Ok to remove USB drive'.

It is now safe to remove the USB drive. This ensures the logging data file saves to memory complete and does not become corrupt.

4.2.13 ABOUT

Contains important information about the module and the firmware versions. This information may be asked for when contacting DSE Technical Support Department for advice.

About	
Variant	8660 MKII
Application	V3.0.20
USB ID	11A6BAD2E

Variant: DSE86xx MKII
Application Version: The version of the module's main firmware file (Updatable using the Firmware Update Wizard in the DSE Configuration Suite Software).
USB ID: Unique identifier for PC USB connection



Press the **Scroll Down** button to access more information about the module.

About	
Analogue	V1.2.3
Auxiliary	V2.0.12

Analogue: Analogue measurements software version
Auxiliary: The version of the module's auxiliary micro firmware file

About	
Bootstrap	V3.0.23
Bootloader	V3.0.23

Bootstrap: Bootstrap software version
Bootloader: Firmware Update bootloader software version

LCD Heater	
Heater Not Fitted	

Heater Fitted/Not Fitted: Indicates if the module has a display heater fitted to enable operation at lower temperatures.

4.3 USER CONFIGURABLE INDICATORS

These LEDs are configured by the user to indicate any one of **100+ different functions** based around the following:-

Indications - Monitoring of a digital input and indicating associated functioning user's equipment - Such as *Battery Charger On, etc.*

Warnings & Electrical Trips - Specific indication of a particular warning or shutdown condition, backed up by LCD indication - Such as *Mains Reverse Power, R.O.C.O.F, etc.*

Status Indications - Indication of specific functions or sequences derived from the modules operating state - Such as *System in Auto, Check Sync, Panel Locked, etc.*



5 OPERATION

NOTE: The following descriptions detail the sequences followed by a module containing the standard 'factory configuration'. Always refer to your configuration source for the exact sequences and timers observed by any particular module in the field.

5.1 QUICKSTART GUIDE

This section provides a quick start guide to the module's operation.

5.1.1 STARTING THE GENERATOR(S)

NOTE: For further details, see the section entitled *Operation* elsewhere in this document.



5.1.2 STOPPING THE GENERATOR(S)

NOTE: For further details, see the section entitled *Operation* elsewhere in this document.

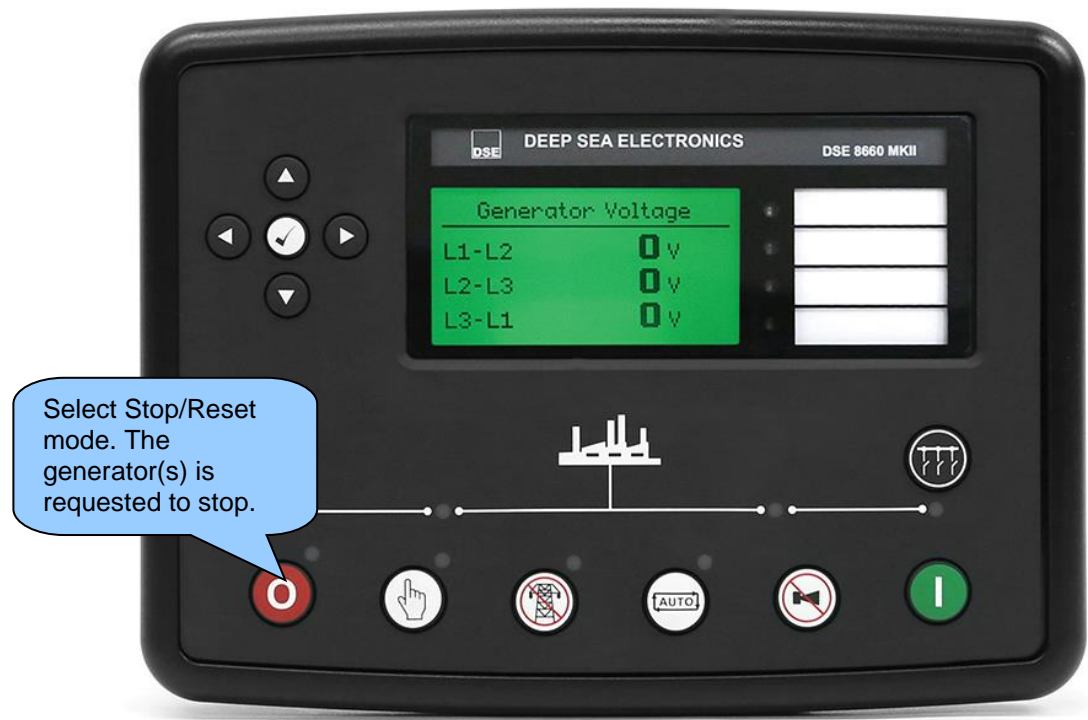



5.2 STOP/RESET MODE

 **NOTE:** If a digital input configured to *Panel Lock* is active, changing module modes is not possible. Viewing the instruments and event logs is **NOT** affected by *Panel Lock*.

 **NOTE:** For further details of module configuration, refer to DSE Publication: *057-257 DSE8660 MKII Configuration Suite Software Manual*.



Stop/Reset Mode is activated by pressing the **Stop/Reset Mode**  button.

The LED above the **Stop/Reset Mode**  button illuminates to indicate **Stop/Reset Mode**  operation.

In **Stop/Reset Mode**  the module removes the generator bus from load (if necessary) before removing the start request on the MSC Link.

When in **Stop/Reset Mode** , it is possible to send configuration files to the module from DSE Configuration Suite PC software and to enter the Front Panel Editor to change parameters.

Any latched alarms that have been cleared are reset when **Stop/Reset Mode**  is entered.



A start request is not sent on the MSC Link when in **Stop/Reset Mode** . If start signals are given, they are ignored until **Auto Mode**  is entered.

If *Immediate Mains Dropout* is enabled and the module is in **Stop/Reset Mode** , the mains load switch is opened and closed as appropriate when the mains fails or becomes available to take load.

5.3 MANUAL MODE

NOTE: If a digital input configured to *Panel Lock* is active on either module, changing modes on both modules is not possible. Viewing the instruments and event logs is NOT affected by panel lock.

Manual Mode is activated by pressing the **Manual Mode**  button.

The LED above the **Manual Mode**  button illuminates to indicate **Manual Mode**  operations.

In **Manual Mode** , a start request does not occur automatically.

To create a start request, press the **Start**  button.

5.3.1 STARTING SEQUENCE

NOTE: There is no *Start Delay* in this mode of operation.

NOTE: For further details of module configuration, refer to DSE Publication: *057-257 DSE8660 MKII Configuration Suite Software Manual*.

A start request is sent to all the DSE8x10 modules on the MSC link. The type of start request sent from the DSE8660 MKII is dependant upon module configuration. The type of start signal is either *Remote Start on Load* or *Remote Start on Load Demand*. The starting sequence of the generator(s) is then controlled by the DSE8x10s.

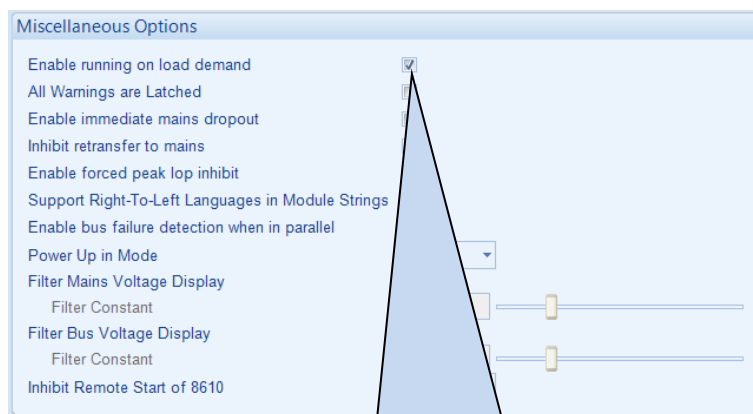

Tick box to set MSC start signal to be *Remote Start on Load Demand*.

5.3.2 LOADING GENERATOR BUS

Once the generator(s) closes its load switch, the generator bus is seen as available and the generator bus LED illuminates.

In **Manual Mode** , the generator bus load switch is not closed until a 'loading request' is made. A loading request can come from a number of sources:

- Press the **Transfer to Generator Bus**  button. The operation of this button is dependant on module configuration, for further details see section entitled *Control Push Buttons* elsewhere in this manual.
- With *Manual Breaker Control* disabled, the following loading requests take affect.

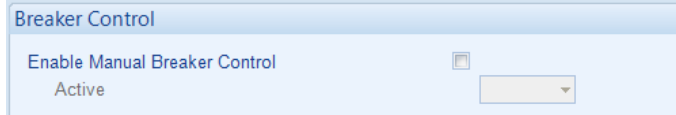





- Failure of mains supply
- High mains load (when the module is set for *Mains Mode*)
- Activation of an auxiliary input that has been configured to *Remote Start on Load* function.
- Activation of an auxiliary input that has been configured to *Auxiliary Mains Failure*.
- Activation of the inbuilt exercise scheduler if configured for *Parallel* or *Island* operation.
- Instruction from external remote telemetry devices using the RS232, RS485 or Ethernet interface.

The generator bus is then instructed to go into continuous parallel with the mains or into island operation, for further details see section entitled *Continuous Parallel Operation* and/or *Island Operation* elsewhere in this manual.

Before closing the generator bus breaker, the generator bus is synchronised to the mains (if required) and is placed on load by ramping load (if required) onto the generator bus from the mains.



5.3.3 UNLOADING GENERATOR BUS

Once the generator bus has been placed on load, it is not automatically removed. To instruct the generator bus to ramp its load off and open its load switch, ensure none of the loading requests are active or have *Manual Breaker Control* enabled and either:

- Press the **Transfer to Mains**  button. The operation of this button is dependant on module configuration, for further details see section entitled *Control Push Buttons* elsewhere in this manual.
- Press the **Auto Mode**  button to return to automatic mode. The module observes all **Auto Mode**  start requests and stopping timers before beginning the *Auto Mode Stopping Sequence*.
- Press the **Stop/Reset Mode**  button to open the generator bus load switch and remove start request on MSC link.
- Activation of an auxiliary input that has been configured to *Bus Load Inhibit* (no ramping occurs)

5.3.4 STOPPING SEQUENCE



In **Manual Mode**  the set continues to run until either:

- The **Stop/Reset Mode**  button is pressed – The generator bus load switch opens immediately and start request on MSC link is removed.
- The **Auto Mode**  button is pressed. The module observes all **Auto Mode**  start requests and stopping timers before beginning the *Auto Mode Stopping Sequence*.

5.4 TEST MODE

NOTE: If a digital input configured to *Panel Lock* is active on either module, changing modes on both modules is not possible. Viewing the instruments and event logs is NOT affected by panel lock.

Test Mode is activated by pressing the **Test Mode**  button.

The LED above the **Test Mode**  button illuminates to indicate *Test Mode*  operations.

In *Test Mode* , a start request does not occur automatically.

To create a start request, press the **Start**  button.

5.4.1 STARTING SEQUENCE

NOTE: There is no *Start Delay* in this mode of operation.

NOTE: For further details of module configuration, refer to DSE Publication: *057-257 DSE8660 MKII Configuration Suite Software Manual*.

A start request is sent to all the DSE8x10 modules on the MSC link. The type of start request sent from the DSE8660 MKII is dependant upon module configuration. The type of start signal is either *Remote Start on Load* or *Remote Start on Load Demand*. The starting sequence of the generator(s) is then controlled by the DSE8x10s.

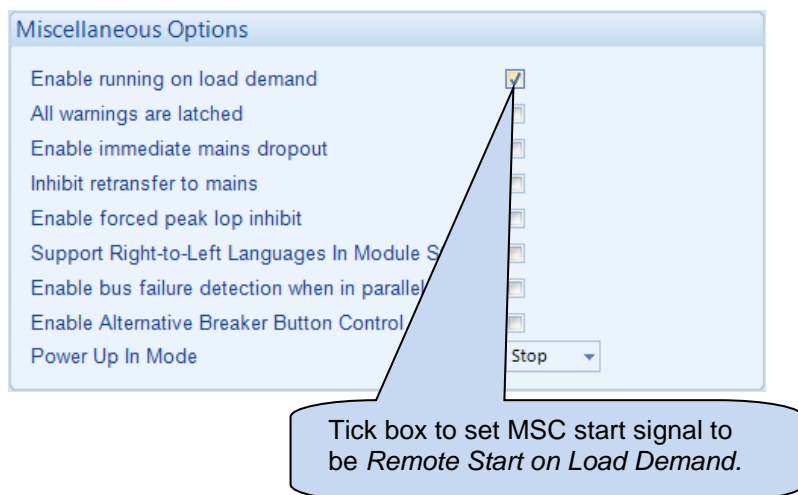

5.4.2 LOADING GENERATOR BUS

Once the generator(s) closes its load switch, the generator bus is seen as available and the generator bus LED illuminates.

In **Test Mode** , the generator bus load switch is closed automatically when the generator bus is seen as available.





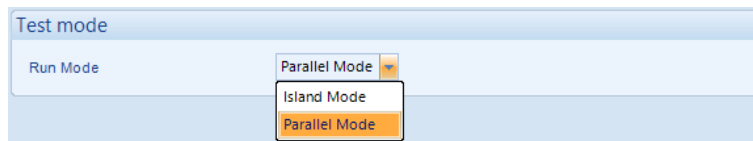

Before closing the generator bus breaker, the generator bus is synchronised to the mains (if required) and is placed on load by ramping load (if required) onto the generator bus from the mains.

Depending upon module configuration, the generator bus is then instructed to go into continuous parallel with the mains or into island operation, for further details see section entitled *Continuous Parallel Operation* and/or *Island Operation* elsewhere in this manual.







5.4.3 UNLOADING GENERATOR BUS

Once the generator bus has been placed on load, it is not automatically removed. To instruct the generator bus to ramp its load off and open its load switch, ensure none of the loading requests are active or have *Manual Breaker Control* enabled and either:

- Press the **Manual Mode**  button and then press the **Transfer to Mains**  button. The operation of **Transfer to Mains**  button is dependant on module configuration, for further details see section entitled *Control Push Buttons* elsewhere in this manual.
- Press the **Auto Mode**  button to return to automatic mode. The module observes all **Auto Mode**  start requests and stopping timers before beginning the *Auto Mode Stopping Sequence*.
- Press the **Stop/Reset Mode**  button to open the generator bus load switch and remove start request on MSC link.
- Activation of an auxiliary input that has been configured to *Bus Load Inhibit* (no ramping occurs)

5.4.4 STOPPING SEQUENCE



In **Test Mode**  the generator bus continues to run until either:

- The **Stop/Reset Mode**  button is pressed – The generator bus load switch opens immediately and start request on MSC link is removed.
- The **Auto Mode**  button is pressed. The module observes all **Auto Mode**  start requests and stopping timers before beginning the *Auto Mode Stopping Sequence*.

5.5 AUTOMATIC MODE

 **NOTE:** If a digital input configured to *Panel Lock* is active on either module, changing modes on both modules is not possible. Viewing the instruments and event logs is NOT affected by panel lock.

Auto Mode is activated by pressing the **Auto Mode**  button.

The LED above the **Auto Mode**  button illuminates to indicate **Auto Mode**  operations.

Auto Mode  allows the system to operate fully automatically, sending start request on the MSC link as required with no user intervention.

5.5.1 WAITING IN AUTO MODE

If a starting request is made, the starting sequence begins.
Starting requests are from the following sources:

- Failure of mains supply
- High mains load (when the module is set for *Mains Mode*)
- Activation of an auxiliary input that has been configured to *Remote Start* function.
- Activation of an auxiliary input that has been configured to *Auxiliary Mains Failure*.
- Activation of the inbuilt exercise scheduler if configured for *Parallel, Island* or *Off Load* operation.
- Instruction from external remote telemetry devices using the RS232, RS485 or Ethernet interface.

5.5.2 STARTING SEQUENCE

To allow for 'false' start requests, the *Start Delay* timer begins.

Should all start requests be removed during the *Start Delay* timer, the unit returns to a stand-by state.

If a start request is still present at the end of the *Start Delay* timer, the start request is activate on the MSC link.

The starting sequence is then controlled in the DSE8x10 module.

5.5.3 LOADING GENERATOR BUS

Once the generator closes its load switch, the generator bus is seen as available and the generator bus LED illuminates.

In **Auto Mode** , the generator bus load switch is closed automatically (if instructed too) when the generator bus is seen as available. A loading request can come from a number of sources:



- Failure of mains supply
- High mains load (when the module is configured for *Mains Mode*)
- Activation of an auxiliary input that has been configured to *Remote Start On Load* or *Remote Start In Island Mode* function.
- Activation of an auxiliary input that has been configured to *Auxiliary Mains Failure*.
- Activation of the inbuilt exercise scheduler if configured for *Parallel* or *Island* operation.
- Instruction from external remote telemetry devices using the RS232, RS485 or Ethernet interface.

The generator bus is then instructed to go into continuous parallel with the mains or into island operation, for further details see section entitled *Continuous Parallel Operation* and/or *Island Operation* elsewhere in this manual.



Before closing the generator bus breaker, the generator bus is synchronised to the mains (if required) and is placed on load by ramping load (if required) onto the generator bus from the mains.

5.5.4 UNLOADING GENERATOR BUS

To instruct the generator bus to ramp its load off and open its load switch:

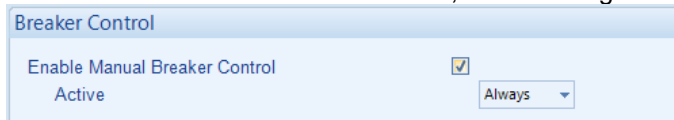
- Press the **Auto Mode**  button. The module observes all **Auto Mode**  start requests and stopping timers before beginning the *Auto Mode Stopping Sequence*.
- Press the **Stop/Reset Mode**  button to open the generator bus load switch and remove start request on MSC link.
- Activation of an auxiliary input that has been configured to *Bus Load Inhibit* (no ramping occurs)
- With *Manual Breaker Control* enabled, the following unloading requests take affect.



- Press the **Manual Mode**  button followed by the **Transfer to Mains**  button. The operation of **Transfer to Mains**  button is dependant on module configuration, for further details see section entitled *Control Push Buttons* elsewhere in this manual.

5.5.5 STOPPING SEQUENCE

If all start requests are removed, the *Stopping Sequence* begins.

In **Auto Mode** , the *Return Delay* timer operates to ensure that the starting request has been permanently removed and isn't just a short term removal. Should another start request be made during the *Return Delay* period, the timer stops.

If there are no starting requests at the end of the *Return Delay* timer, the generator bus load switch opens and the start request on the MSC link is removed.

5.6 ISLAND OPERATION (LOAD SHARE)

NOTE: For further details on the DSE Load Demand Scheme (the automatic starting/stopping of generators based on load demand), refer to DSE Publication: 056-013 *Load Demand Scheme*.

NOTE: The V6 software MSC is not compatible with the previous module versions. For more information contact DSE Technical Support support@deepseaelectronics.com. The v7.0 and later module versions have the *Load Demand Scheme Compatibility* option to configure the required MSC compatibility, “86xx current” for module versions v6.1 and later, or “86xx up to v5.1” for module versions up to v5.1. For more details refer to DSE Publication: 057-257 *DSE8660 MKII Configuration Suite PC Software Manual*.

The generator bus can be started during a mains failure or when the load level starts to exceed the rating of the mains. The generator bus in this case must be capable of supplying the entire load during this time. The generator bus can then be used to power the load by:

- *Synchronising No-break (Close Transition) Transfer* if the mains is available
- by closing the generator bus breaker onto the load without synchronising if the mains supply had failed.

This leaves the generator bus running in *Island Operation*, supplying the load entirely on its own. This is the case until the load is transferred back to the mains using a synchronising no break (close transition) transfer, if the mains is available.

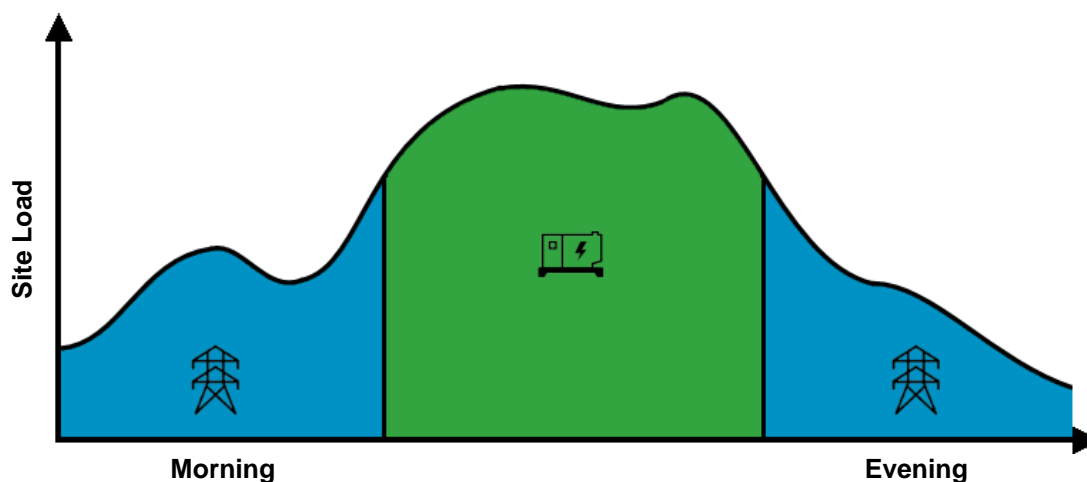

When generators are running in parallel isochronously (zero droop) with one another in *Island Operation*, the amount of power they produce to the load has to be controlled to ensure it is shared amongst them.

It is the job of the DSE8x10 to make precise changes to the amount of power supplied by each generator to the resistive element (*Active Power*) and capacitive/inductive element (*Reactive Power*). The *Active Power* (kW) sharing is achieved by controlling the engine's governing system. This is done to alter the amount of fuel supplied to the engine and then monitor the amount of *Active Power* (kW) supplied by the generator. The *Reactive Power* (kvar) sharing is achieved by controlling the alternator's AVR. This is done to alter the amount of field excitation supplied to the alternator and then monitor the amount of *Reactive Power* (kvar) supplied by the generator.

The DSE8x10 knows it is in island operation due to commands sent down the MSC link from the DSE8x60, as it knows the status of the mains and generator bus breaker.

Operation

The DSE8x10 controllers communicate with one another using the MSC link, passing information and instructions between themselves regarding the amount of power to produce. This information is also used to automatically bring in or drop off other generating sets as load changes if the option for *Enable Running on Load Demand* is enabled in the DSE8x60.

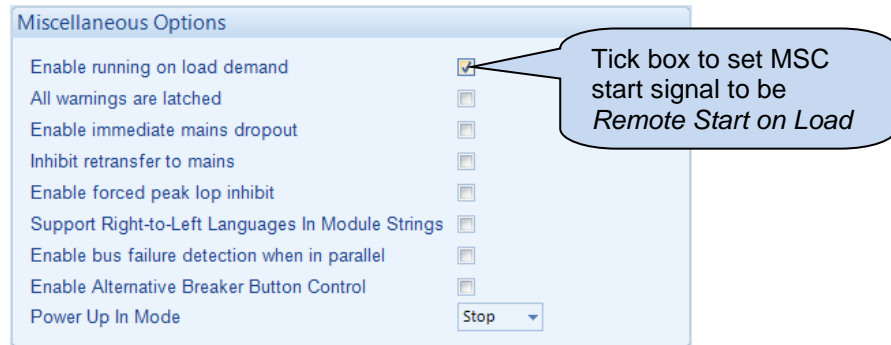

Whilst generators are in parallel, the DSE8x10 controllers instruct the generators to produce an equal percentage of the generators rating. In the example below, the mains has failed so is not producing any power to the load. One generator is twice the size of the other though both generators are instructed to produce 80 % of their kW rating and 40 % of their kvar rating. This ensures that one generator is not being overworked, preventing excessive wear.

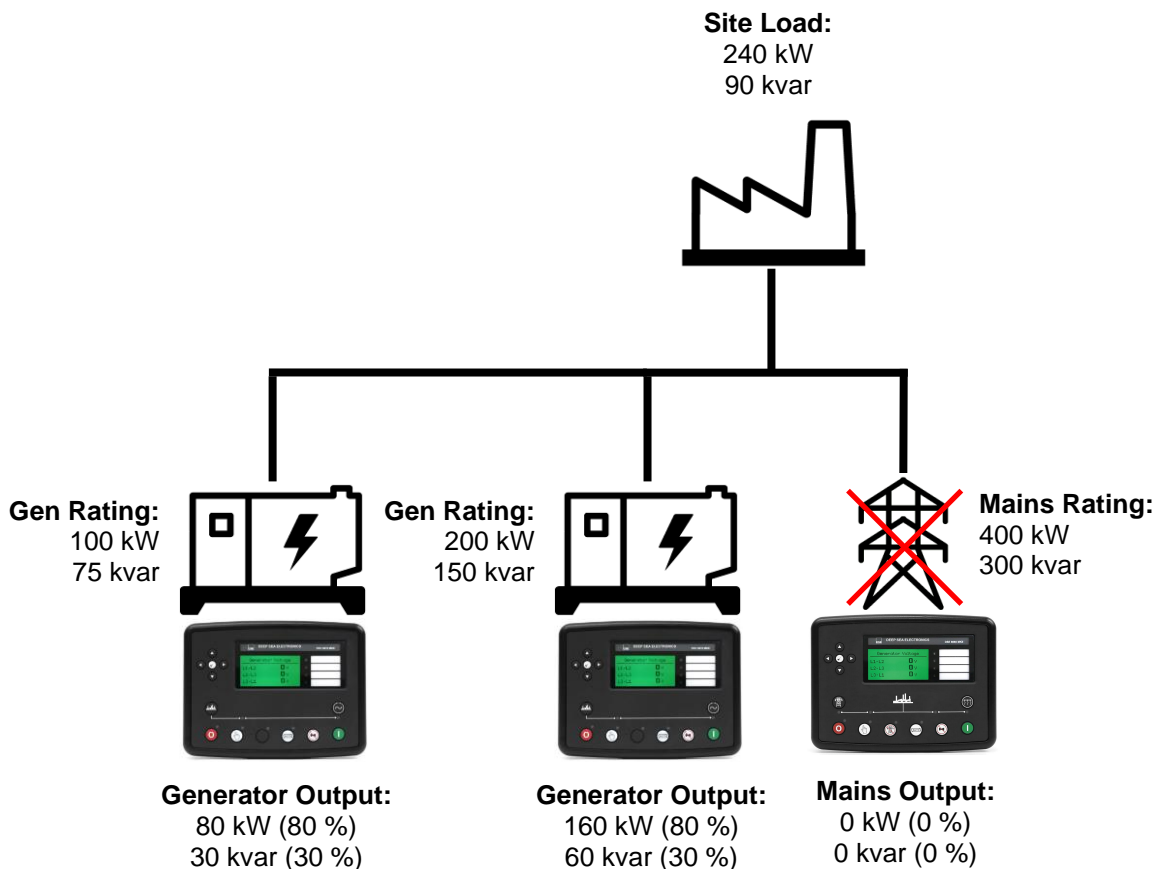

5.7 CONTINUOUS PARRALLEL OPERATION

5.7.1 BUS MODE (FIXED EXPORT / BASE LOAD)

During specified times of the day, the generator bus can be started and parallel to the mains using the *Remote Start on Load* input to the DSE8x60. When the DSE8x60 is set to *Bus Mode*, this causes the generator bus to produce a fixed (base) level of power against the mains, synchronising to the mains before closing the generator bus breaker.

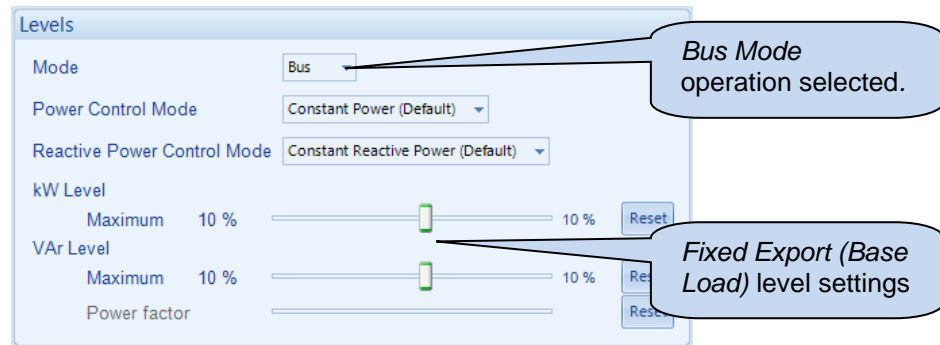

This leaves the generator bus running in *Continuous Fixed Export (Base Load) Parallel Operation*. The fixed (base) level of power produced by the generator bus supplies the local load and any excess is exported to the mains. This is the case until the *Remote Start on Load* signal is removed from the DSE8x60 module.

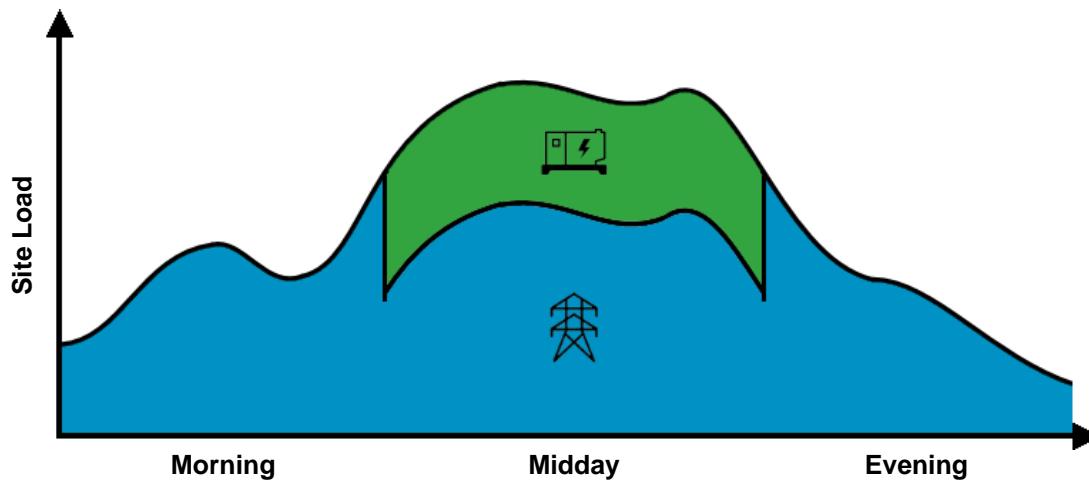

When a generator is running in parallel with the mains isochronously (zero droop) in *Continuous Parallel Operation*, the amount of power they produces has to be controlled.

It is the job of the DSE8x10s to make precise changes to the amount *Active Power* (kW) and *Reactive Power* (kvar) produced by their respective generator. The *Active Power* (kW) regulation is achieved by controlling the engine's governing system. This is done to alter the amount of fuel supplied to the engine and then monitor the amount of *Active Power* (kW) produced by the generator. The *Reactive Power* (kvar) regulation is achieved by controlling the alternator's AVR. This is done to alter the amount of field excitation supplied to the alternator and then monitor the amount of *Reactive Power* (kvar) supplied by the generator.

The DSE8x10 knows it is going to parallel the generator with a mains supply due to commands sent down the MSC link from the DSE8x60, as it knows the status of the mains and generator bus breaker.

Operation

When the generator bus is paralleled to the mains, the DSE8x60 instructs all the DSE8x10 controllers to instruct their generator to produce the same pre-set percentage of the generators rating. This pre-set percentage is changeable whilst the generator is running via a multitude of different interfaces. In the example below, the generator bus is instructed to produce 80 % of its kW rating and 30 % of its kvar rating. This results in 140 kW being exported to the Mains and the Mains only producing 10 kvar as the local site load consumes the majority of the power produced by the generator.

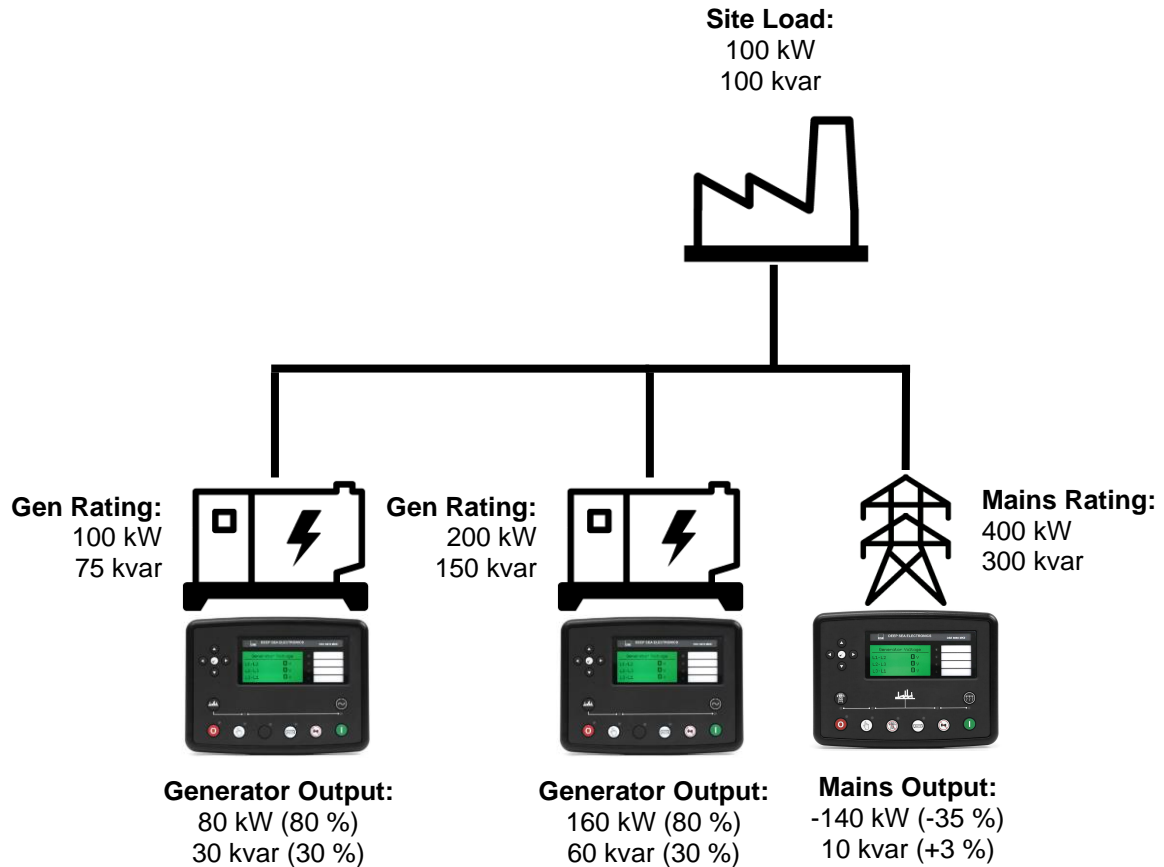

5.7.2 POWER MODES

 **NOTE:** The *Frequency and Active Power Control* modes and *Voltage and Reactive Power Control* modes are to be used in conjunction with the following documents:
- COMMISSION REGULATION (EU) 2016/631 of 14 April 2016 establishing a network code on requirements for grid connection of generators
- P1547 - IEEE Draft Standard for Interconnection and Interoperability of Distributed Energy Resources with Associated Electric Power Systems Interfaces

 **NOTE:** For further details of the configuration for the different power modes, refer to DSE Publication: 057-257 *DSE8660 MKII Configuration Suite Software Manual*.

It is sometimes required that when a generator is placed in parallel with the mains, that it does not simply produce a fixed amount of *Active Power (kW)* or *Reactive Power (kvar)*. It may be required that the generator automatically varies the amount of *Active Power (kW)* or *Reactive Power (kvar)* to stabilise the localised Mains voltage and frequency. For these requirements, the DSE modules have the option to change the mode of operation whilst in parallel with the Mains.

5.7.2.1 FREQUENCY AND ACTIVE (KW) POWER MODES

Constant Active Power Mode (Default)

This is the default mode of exporting power to the mains (utility); where the DSE load share controller holds the amount of active power produced at a constant level. The amount of active power produced by the generator is irrespective of the load level or any other parameter.

The amount of power produced is defined as *Maximum kW Level* and is set using either the *DSE Configuration Suite PC Software*, *Front Panel Running Editor*, in PLC Functions, or via Modbus messages.

Frequency - Active Power Mode

In this mode of exporting power to the mains (utility); the DSE load share controller varies the amount of active power produced with regards to the *Control Curve* depending on the measured mains (utility) frequency.

This mode allows the generator to support the mains (utility) frequency stability by monitoring the frequency and changing the amount of active power produced.

Voltage – Active Power Mode

In this mode of exporting power to the mains (utility); the DSE load share controller varies the amount of active power produced with regards to the *Control Curve* depending on the measured mains (utility) voltage.

This mode allows the generator to support the mains (utility) voltage stability by monitoring the voltage and changing the amount of active power produced.

5.7.2.2 VOLTAGE AND REACTIVE (KVAR) POWER CONTROL

Constant Reactive Power Mode (Default)

This is the default mode of exporting power to the mains (utility); where the DSE load share controller holds the amount of reactive power produced at a constant level. The amount of reactive power produced by the generator is irrespective of the load level or any other parameter.

The amount of reactive power produced is defined as *Maximum kVAr Level* and is set using either the *DSE Configuration Suite PC Software, Front Panel Running Editor*, in PLC Functions, or via Modbus messages.

The user has the option to limit the amount of reactive power the generator produces to within their power factor depending on the amount of active power produced. Regardless of this option, the generator does not produce more than its rated reactive power.

Constant Power Factor Mode

In this mode of exporting power to the mains (utility); the DSE load share controller varies the amount of reactive power produced with regards to maintaining the required power factor.

This mode allows the generator to maintain a constant export power factor if so required.

The required power factor is set using either the *DSE Configuration Suite PC Software, Front Panel Running Editor*, in PLC Functions, or via Modbus messages.

Voltage - Reactive Power Mode

In this mode of exporting power to the mains (utility); the DSE load share controller varies the amount of reactive power produced with regards to the *Control Curve* depending on the measured voltage.

This mode allows the generator to support the mains (utility) voltage stability by monitoring the voltage and changing the amount of reactive power produced.

Power - Power Factor Mode

In this mode of exporting power to the mains (utility); the DSE load share controller varies the amount of reactive power produced with regards to maintaining the required power factor. This power factor is derived from the averaged power using the *Control Curve*.

This mode allows the generator to support the mains (utility) stability by varying the power factor depending on the produced active power.

5.7.2.3 SIMULATION INJECTION TESTING

 **NOTE: For further details about the Simulation Injection Testing, refer to DSE Publication: 056-123 *Simulation Injection Testing*.**

The *Simulation Injection Testing* enables the user to override the DSE module's measurements of the bus generator(s) voltage and frequency. This is provided so the various *Power Modes* for mains parallel can be tested without having to alter the main's actual voltage and frequency. The simulation injection is controlled via the DSE Configuration Suite PC Software or through the MODBUS communication.

To use the *Simulation Injection Testing* on the DSE module, the *Voltage and Frequency Injection Testing* parameter must be set to Active from the *Running Editor*. Refer to section entitled '*Running Configuration Editor*' elsewhere in this document. Once the *Voltage and Frequency Injection Testing* parameter is set to active, it remains active for only three minutes. The *Voltage and Frequency Injection Testing* timer is seen from the *Running Editor*.

5.7.3 MAINS MODE (PEAK LOPPING/SHAVING)

During specified times of the day, the generator bus can be started and paralleled to the mains using the *Remote Start on Load* input to the DSE8x60. When the DSE8x60 is set to *Mains Mode*, this causes the generator bus to only start and synchronise to the mains when the load level rises above a pre-defined mains load level.

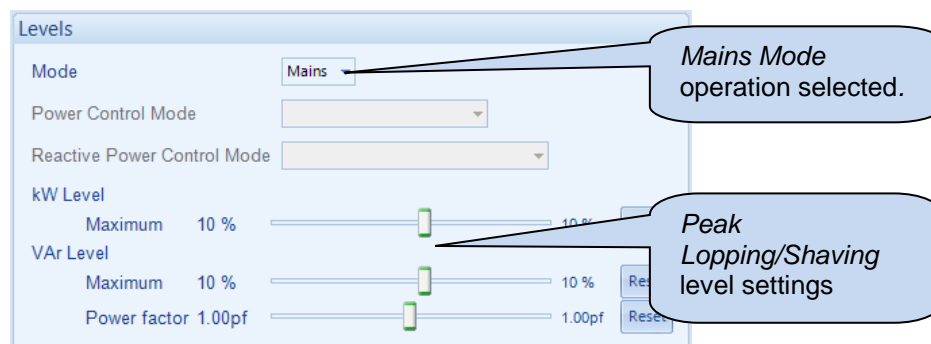

This leaves the generator bus running in *Continuous Peaking Lopping/Shaving Parallel Operation*. The amount of power produced by the generator bus whilst in parallel with the mains is constantly varied to maintain the mains at the pre-defined load level. This is the case until the *Remote Start on Load* signal is removed from the DSE8x60 module or the total site load falls below the *Peak Lopping/Shaving* level settings. .

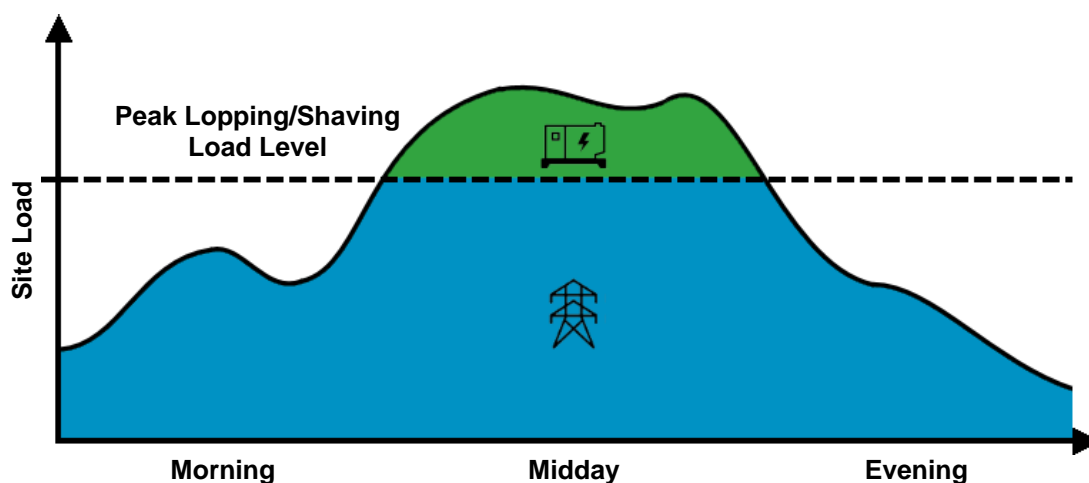

When a generator is running in parallel with the mains isochronously (zero droop) in *Continuous Parallel Operation*, the amount of power they produces has to be controlled.

It is the job of the DSE8x10s to make precise changes to the amount *Active Power* (kW) and *Reactive Power* (kvar) produced by their respective generator. The *Active Power* (kW) regulation is achieved by controlling the engine's governing system. This is done to alter the amount of fuel supplied to the engine and then monitor the amount of *Active Power* (kW) produced by the generator. The *Reactive Power* (kvar) regulation is achieved by controlling the alternator's AVR. This is done to alter the amount of field excitation supplied to the alternator and then monitor the amount of *Reactive Power* (kvar) supplied by the generator.

Operation

The DSE8x10 knows it is going to parallel the generator with a mains supply due to commands sent down the MSC link from the DSE8x60, as it knows the status of the mains and generator bus breaker. This information is also used to automatically bring in or drop off other generating sets as load changes if the option for *Enable Running on Load Demand* is enabled in the DSE8x60.

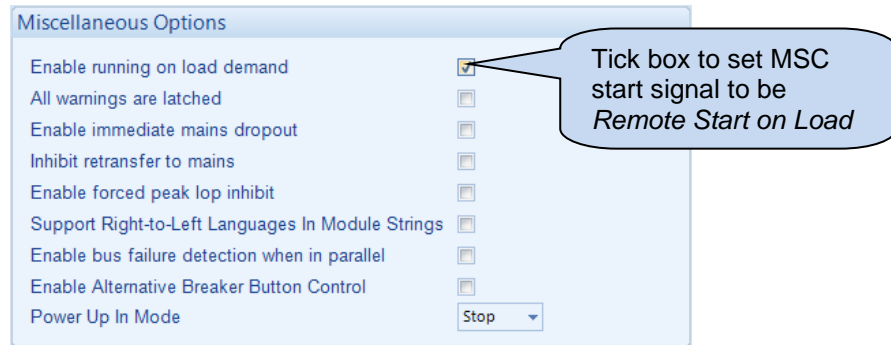

When the generator bus is paralleled to the mains, the DSE8x60 instructs all the DSE8x10 controllers to instruct their generator to produce an equal percentage of the generators rating to maintain the mains at the pre-set percentage. This pre-set percentage is changeable whilst the generator is running via a multitude of different interfaces. In the example below, the mains pre-set percentages are set to 80%. The generator bus is then instructed to produce the excess requirement from the load. As the excess is small, only one generator is required and produced 40 % of its kW rating and 40 % of its kvar rating. This results in the mains power being maintained at 360 kW and 270 kvar whilst only one generator produces the additional 40 kW and 30 kvar to the load.

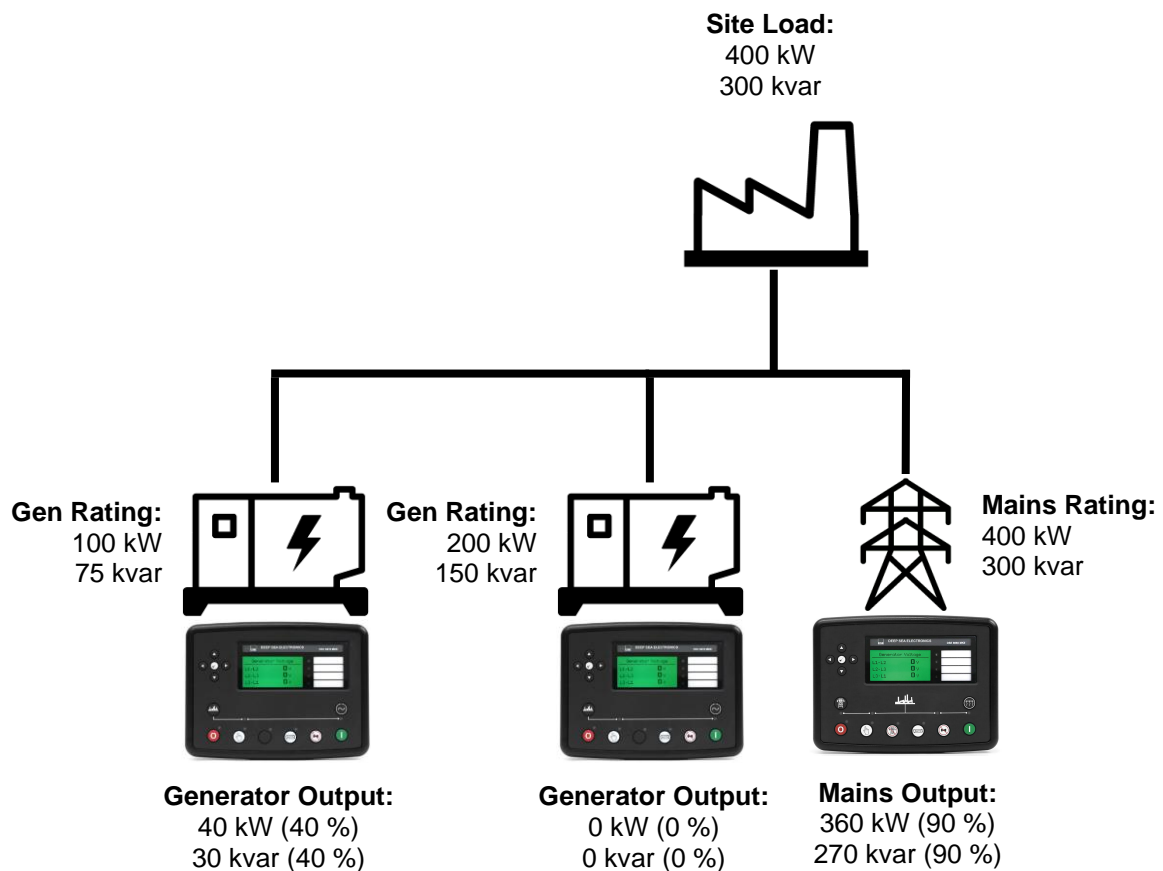

5.8 MULTIPLE MAINS OPERATION

NOTE: At no time are the generators paralleled with more than one mains supply. Paralleling with mains supplies is always taken in turn.

In a multiple mains system, the generator bus is controlled by more than one DSE8660 MKII mains controller and used to provide power to load change overs.

Should one or more of the mains supplies fail, the generator bus (controlled by DSE 8x10 modules) is started and used to supply power to the multiple load change overs. If more than one mains supply has failed, the loads are transferred to the generator bus one by one in order of the *Priority* of the DSE8660 MKII modules.

The DSE8x10 controllers share power equally on a percentage basis with the other generators in the system.

- If one mains supply returns, the DSE8660 MKII connected to that mains supply synchronises the generator bus with the mains and performs a no-break changeover. The generator bus continues to supply power to the remaining loads from the other change overs.
- If more than one mains supply returns at the same time, then the DSE8660 MKII with the highest priority takes control of the generator bus and performs a no-break changeover back to the mains supply. The remaining DSE8660 MKIIs operate in priority order, one at a time, providing no-break returns back to their respective mains supplies.

If the generator bus is 'peak-logging' with one mains supply, and another mains supply fails, dependent upon module configuration, the generators either:

- Continue to peak-lop as before. The load with the mains supply that has failed remains without power.
- Cease peak-logging and backup the failed mains supply.

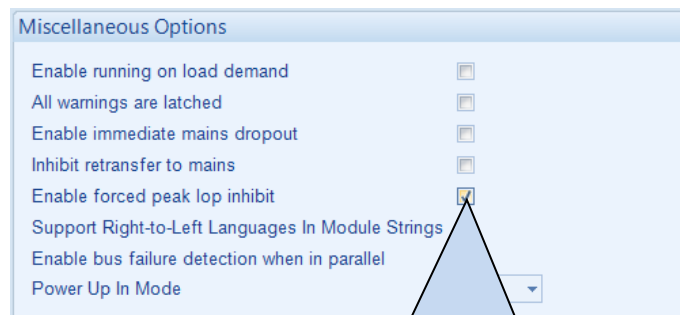

Tick box to cease peak-logging when another DSE8x60 mains fails

5.8.1 DSE8660 MKII PRIORITY

NOTE: If a DSE8x60 requests to control the generator bus (either automatically or manually) it will not be allowed to do so until the higher priority DSE8x60 and DSE8x80 controllers have relinquished control over the generator bus.

Where more than one DSE8660 MKII controller is present, they determine which one is to take control over the generator bus. The following table shows how this priority decision is made.

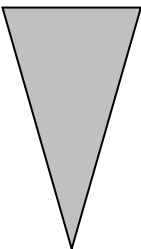
Priority	Condition
	Auto mode, mains failed, bus not on load
	Auto mode, mains has returned
	Auto mode, mains failed, bus on load
	Auto mode, mains available, requesting control over generators
	Test on load mode
	Manual mode, sets running or about to run (start button has been pressed)
	Auto mode, mains available
	Manual mode, sets not running (waiting for start button to be pressed)
	Stop mode

Where two or more DSE8660 MKII controllers have the same conditions in the table above, the *Priority Numbers* of the DSE8660 MKII comes into effect. If a combination of two or more DSE8660 MKII or DSE8680 controllers have the same priority number, an electrical trip alarm is generated - *Priority Selection Error* - and the priority numbers must be changed before the system operates.

For typical one line diagram of a multi-mains system, see the section entitled *Typical Single Line Application Drawings* elsewhere in this document.

5.8.2 DSE8660 MKII BUS/LOAD CT

NOTE: The Bus/Load CT is **NOT REQUIRED** in a system including only one DSE8x60 controller. For further information regarding the advantages of a Bus/Load CT, refer to section entitled *Bus/Load Current Transformer* elsewhere in this document, or refer to DSE Publication: *056-007 Advantages of Bus/Load CT*.

The DSE8660 MKII controller incorporates an optional (but recommended) extra CT measuring the size of the load or the load produced by the generator bus. Used in conjunction with the CTs measuring the amount of load on the mains supply, this CT allows the DSE8x60 to determine what portion of the load is being supplied by the generator bus.

This allows the DSE8x60 to remove the generator bus from this load when there is little or no current passing through the generator bus breaker. For example: When the generators are ramping off load.

5.9 MANUAL BUS VOLTAGE & FREQUENCY CONTROL IN ISLAND MODE

NOTE: This feature is only available on the module's software v7.0 and later.

NOTE: The *Manual Island Mode Bus Limits* are configurable in the DSE8660 MKII module. For further details of module configuration refer to DSE Publication: 057-257 *DSE8660 MKII Configuration Suite PC Software Manual*.

NOTE: The *Manual Bus Adjust* function must be set to active from the PLC Editor to be able to control the bus voltage and frequency from the PLC. For more information refer to DSE Publication: 057-314 *Advanced PLC Software Manual* which is found on our website: www.deepseaelectronics.com

In certain applications where it is required to 'manually' synchronise the generators bus to an external source 'mains' then to manually close the mains switchgear to parallel the generators bus to the mains, the DSE8660 MKII provides the ability to control the bus voltage and bus frequency through the PLC Editor by using the *Bus Voltage Adjust* and the *Bus Frequency Adjust* functions. The *Manual Bus Adjust* function must be set to active from the PLC Editor for the *Bus Voltage Adjust* and the *Bus Frequency Adjust* actions take place. This feature is only applicable when the generators are running in either *Island* mode or *Manual* mode when the mains switchgear is open.

In this instance the user has to configure the *Bus Voltage Adjust* and the *Bus Frequency Adjust* functions to the desired levels in the DSE module's PLC, which then take action on certain conditions such as digital inputs activation.

It is also possible to control the *Bus Voltage Adjust* and the *Bus Frequency Adjust* levels through the MODBUS communication.

This operation only takes place when all the following conditions are satisfied:

- The DSE8660 MKII is running the generators in *Island Mode* or in *Manual Mode* with the mains switchgear open.
- In multi-mains system the DSE8660 MKII has the Control over the DSE8x10 modules.
- The *Manual Bus Adjust* is set to active in the module.

The DSE8660 MKII's *Manual Island Mode Bus Limits* must be configured using the DSE Configuration Suite to set the bus voltage bias control limit and the bus frequency bias control limit for the DSE8660 MKII controls the DSE8x10 generators carefully and avoid requesting a control range that the generators do not support. For instance if one or more of the generators on the bus supports a maximum of +/-25 V change, then the *Manual Voltage Limit* in the DSE8660 MKII's configuration must be configured to 25.0 V, similarly if one or more of the generators on the bus supports a maximum of +/-3 Hz change, then the *Manual Frequency Limit* in the DSE8660 MKII's configuration must be configured to 3.00 Hz. In this way the DSE8660 MKII does not request more than what those generators are able to accept, and these limits apply on all the DSE8x10 generators on the bus when the DSE8660 MKII is controlling them through the MSC Link. The *Manual Voltage Limit* and *Manual Frequency Limit* parameters are shown below.

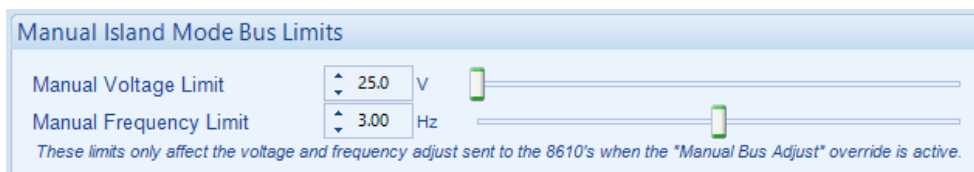

5.10 SCHEDULER

The controller contains an inbuilt exercise run scheduler, capable of automatically starting and stopping the set. Up to 16 scheduled start/stop sequences can be configured to repeat on a 7-day or 28-day cycle. Scheduled runs may be island, off load or parallel depending upon module configuration.

Example

Screen capture from DSE Configuration Suite Software showing the configuration of the Exercise Scheduler.

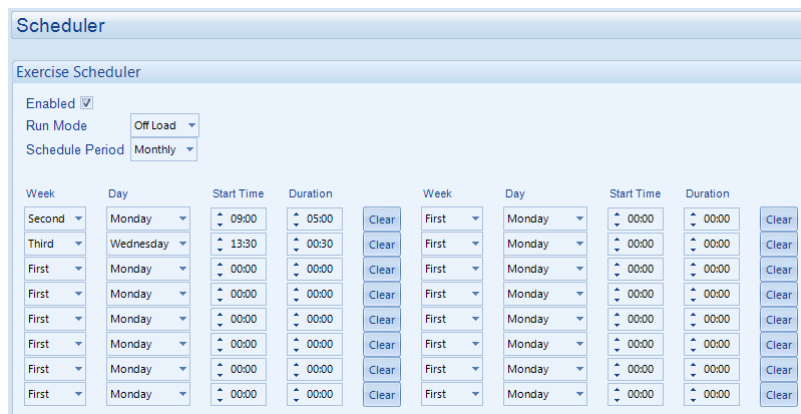

In this example the start request is made on Monday in the Second Week of each month at 09:00 am and lasts for 5 hours, then Wednesday in the Third Week of each month at 13:30 pm and lasts for 30 minutes.





5.10.1 STOP/RESET MODE

- Scheduled runs do not occur when the module is in **Stop/Reset Mode** .





5.10.2 MANUAL MODE

- Scheduled runs do not occur when the module is in **Manual Mode**  waiting for a start request.
- Activation of a Scheduled Run in *Parallel* or *Island* when the module is operating *Off Load* in **Manual Mode**  forces the generator bus to the appropriate state.

5.10.3 TEST MODE

- Scheduled runs do not occur when the module is in **Test Mode**  waiting for a start request.
- Activation of a Scheduled Run in *Parallel* or *Island* when the module is operating *Off Load* in **Test Mode**  forces the generator bus to the appropriate state.

5.10.4 AUTO MODE

- Scheduled runs operate only if the module is in **Auto Mode**  with no *Electrical Trip* alarm active.
- If the module is in **Stop/Reset Mode**  or **Manual Mode**  when a scheduled run begins, the start request is not given. However, if the module is moved into **Auto Mode**  during a scheduled run, the start request is given.
- If the generator bus is running *Off Load* in **Auto Mode**  and a scheduled run configured to *Parallel* or *Island* begins, the generator bus is forced to the appropriate state for the duration of the Schedule.
- Depending upon configuration by the system designer, an external input can be used to inhibit a scheduled run.

5.11 MSC COMPATIBILITY MODE

NOTE: These settings enable the interface between the DSE86xx MKII controllers and the legacy DSE55xx and DSE75xx controllers.

Parameter	Description
MSC Compatibility	<p>NOTE: The DSE5560 and DSE7560 are not compatible with the DSE8660 MKII, only one type of DSExx60 can be connected on the MSC at any time (DSE5560/DSE7560 OR DSE8660 MKII).</p> <p><input type="checkbox"/> = The DSE86xx MKII is not be able to communicate with the DSE55xx and DSE75xx series modules on the MSC Link. <input checked="" type="checkbox"/> = Communication between DSE86xx MKII and DSE55xx/DSE75xx is enabled. The maximum number of DSExx10 controllers is reduced to 16 and the maximum number of DSExx60 controllers is reduced to 8.</p>

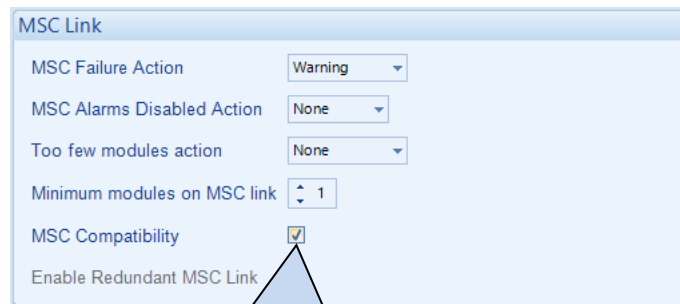





MSC Link compatibility with DSE5510/DSE7510 modules

5.12 SMS CONTROL



NOTE: Multiple SMS Control Commands CANNOT be sent in a single SMS message.

The *SMS Control* feature (if enabled) allows the user to send control commands to the module via SMS message. There are five control commands that the user is able to send to the module shown in the table below.

Control Command Number	Module Action
1	Start the generator(s) and run off load if the controller is in the Auto Mode  .
2	Start the generator(s) and run in parallel if the controller is in the Auto Mode  .
3	Cancel the SMS start request leaving the module in its current operating mode.
4	Put the module into the Stop/Reset Mode  .
5	Put the module into the Auto Mode  .
6	Start the generator(s) and run in island mode

To send an SMS command, the user requires (if configured) the *SMS Control Pin* and the *Control Command Number*. Only these numbers must be included in the SMS, the module does not respond to any SMS with extra characters or missing PIN (if configured). Below is an example showing how to start and run the generator on load by SMS message.

NOTE: There MUST be a space between the SMS PIN and the Control Command Number

PIN	Control Command Number	Description
0123 5	5	This SMS message places the module into the Auto Mode  .
0123 2	2	This SMS message will start generator and run it on load.
0123 3	3	This SMS message will remove the start and run command given by the previous SMS message and leave the module in the Auto Mode  .
0123 4	4	This SMS message will place the module into the Stop/Reset Mode  .

Example screenshot of *SMS Control* setup in the DSE Configuration Suite:

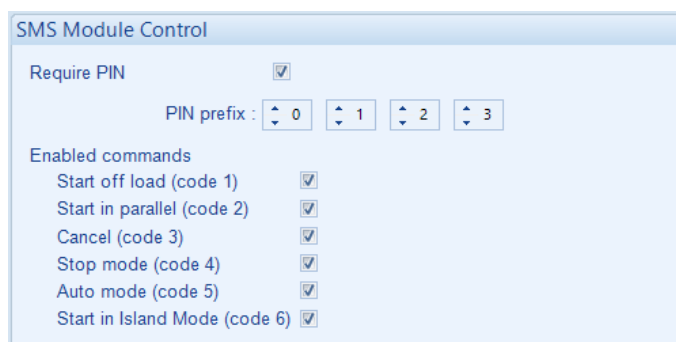

5.13 DEAD BUS SYNCHRONISING (AUTO MODE)

 **NOTE:** For further details on Dead Bus Synchronising, refer to DSE Publication: 056-072 *Dead Bus Synchronising Training Document*.

5.13.1 BENEFIT OF SYSTEM

Generator set specifications often contain the requirement for the set to be on load within 15 seconds of a mains supply failure. This is easily achievable in single set applications. However in the current era of fuel conservation, multiple sets are often used to provide the backup power solution for many applications. This gives challenges in starting and synchronising the required sets before they can be used to power the load.

The solution to this is a longstanding one, having being used for many decades. However modern digital communications such as the DSE MSC link has vastly improved the control and hence safety of the system operation. The solution is called *Dead Bus Synchronising*. Using *Dead Bus Synchronising*, any number of generators are able to be online and in parallel potentially within 15 seconds, depending upon applications and hardware used.

5.13.2 HARDWARE REQUIREMENTS

- DSE8660 MKII controller
- DSE8610 MKII controller
- DC controlled generator load switch
- Auxiliary contact to feed back generator breaker status to the DSE controller.
- External relay driven by the DSE module to isolate the supply to the AVR inside the generator's alternator.
- Speed detection using an MPU or CAN signal.

5.13.3 OPERATION

Before the generator sets are started, their load switches are closed. As there is no AC supply the load switches must be DC controlled. Next, the alternator excitation field is disabled by isolating the supply to the AVR's. The engines are all started at the same time and allowed for the *Excitation Delay* timer to reach the desired operating speed. As there is no AC supply generated, frequency cannot be used to determine engine speed, hence the requirement for an MPU of CAN speed signal.

If the engines have attained the desired engine speed within the *Excitation Delay* timer, the AVR's power supply is reconnected, enabling the excitation field and load sharing begins. The MSC link is used to ensure all sets excite their alternators at exactly the same time. Any generators not up to speed before the end of the *Excitation Delay* timer are instructed to open their load switches. A short time later, these sets synchronise to the bus in the traditional manner.

Status	
Start Delay	00:00 s

The generator load switch is closed, excitation is switched off, start delay if configured.

Status	
Fuel	

Fuel output is activated on the DSE8610 MKII

Status	
Crank Attempt	

Engine is cranked on the DSE8610 MKII

Status	
Excitation Delay	00:03
L-N	0 V 0 A
L-L	0 V 0 Hz
kW	0 kW 0 pf

Excitation Delay before excitation output is activated. Generators run up to speed if any on the MSC are out of limits they are instructed to open their load switches and synchronise in the normal manner.

Status	
Excitation Delay	00:00
L-N	230 V 174 A
L-L	400 V 50 Hz
kW	100 kW 0.8 pf

Excitation output closed & voltage rises to nominal settings.

Status	
On Load	

Once the voltage and frequency are within configurable limits the set(s) can take load.

6 PROTECTIONS

6.1 ALARMS

When an alarm is active, the *Internal Audible Alarm* sounds and the Common Alarm LED, if configured, illuminates.

The audible alarm is silenced by pressing the **Alarm Mute / Lamp Test**  button.

The LCD display jumps from the 'Information page' to display the Alarm Page

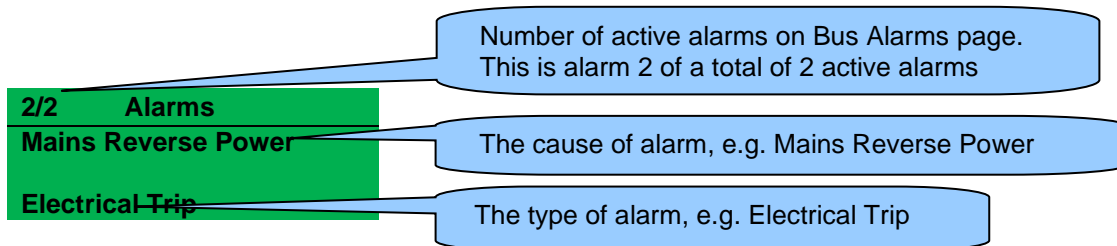
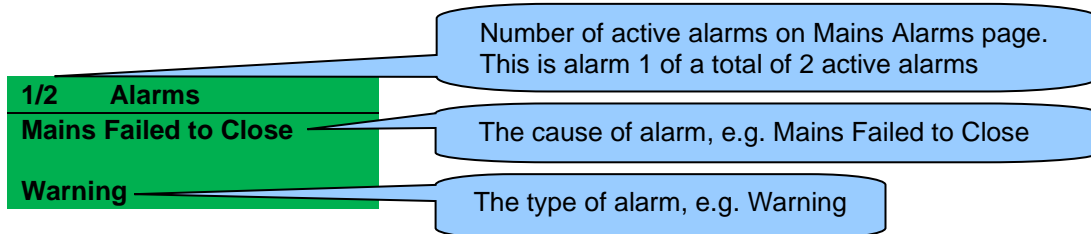

The LCD displays multiple alarms such as "*Mains Failed to Close*" and "*Mains Reverse Power*". These automatically scroll in the order that they occurred.

In the event of an alarm, the LCD displays the appropriate text. If an additional alarm then occurs, the module displays the appropriate text.

Example:

1/2	Alarms
Mains Failed to Close	
Warning	

2/2	Alarms
Mains Reverse Power	
Electrical Trip	

6.2 INDICATIONS

Indications are non-critical and often status conditions. They do not appear on the LCD of the module as a text message. However, an output or LED indicator is configured to draw the operator's attention to the event.

Example

- Input configured for indication.
- The LCD text does not appear on the module display but can be added in the configuration to remind the system designer what the input is used for.
- As the input is configured to *Indication* there is no alarm generated.
- LED Indicator to make LED1 illuminate when Digital Input A is active.
- The Insert Card Text allows the system designer to print an insert card detailing the LED function.
- Sample showing operation of the LED.



6.3 WARNING ALARMS

Warnings are non-critical alarm conditions and do not affect the operation of the system, they serve to draw the operators attention to an undesirable condition.

Example

1/2 Alarms
Mains Failed to Close
Warning

In the event of an alarm the LCD jumps to the appropriate module alarms page, and scrolls through all active alarms.

By default, warning alarms are self-resetting when the fault condition is removed. However enabling *All Warnings Are Latched* causes warning alarms to latch until reset manually. This is enabled using the DSE Configuration Suite in conjunction with a compatible PC.



Fault	Description
2130 ID 1 to 4 Analogue Input E to H High	<p>▲ NOTE: Due to module configuration the alarm message that appears on the display may be different. For further details of module configuration, refer to DSE Publication: 057-257 DSE8660 MKII Configuration Suite PC Software Manual.</p> <p>The module detected that an analogue input value of a DSE2130 had risen above the <i>Flexible Sensor High Pre-Alarm Trip</i> level.</p>
2130 ID 1 to 4 Analogue Input E to H Low	<p>▲ NOTE: Due to module configuration the alarm message that appears on the display may be different. For further details of module configuration, refer to DSE Publication: 057-257 DSE8660 MKII Configuration Suite PC Software Manual.</p> <p>The module detected that an analogue input value of a DSE2130 had fallen below the <i>Flexible Sensor Low Pre-Alarm Trip</i> level.</p>
2130 ID1 to 4 Digital Input A to H	<p>▲ NOTE: Due to module configuration the alarm message that appears on the display may be different. For further details of module configuration, refer to DSE Publication: 057-257 DSE8660 MKII Configuration Suite PC Software Manual.</p> <p>The module detected that a digital input configured to create a fault condition on a DSE2130 expansion module became active and the appropriate LCD message displayed.</p>
2131 ID 1 to 4 Analogue Input A to J High	<p>▲ NOTE: Due to module configuration the alarm message that appears on the display may be different. For further details of module configuration, refer to DSE Publication: 057-257 DSE8660 MKII Configuration Suite PC Software Manual.</p> <p>The module detected that an analogue input value of a DSE2131 had risen above the <i>Flexible Sensor High Pre-Alarm Trip</i> level.</p>

Continued over page...

Fault	Description
2131 ID 1 to 4 Analogue Input A to J Low	<p>▲ NOTE: Due to module configuration the alarm message that appears on the display may be different. For further details of module configuration, refer to DSE Publication: 057-257 DSE8660 MKII Configuration Suite PC Software Manual.</p> <p>The module detected that an analogue input value of a DSE2131 had fallen below the <i>Flexible Sensor Low Pre-Alarm Trip</i> level.</p>
2131 ID 1 to 4 Analogue Input A to J	<p>▲ NOTE: Due to module configuration the alarm message that appears on the display may be different. For further details of module configuration, refer to DSE Publication: 057-257 DSE8660 MKII Configuration Suite PC Software Manual.</p> <p>The module detected that a digital input configured to create a fault condition on a DSE2131 expansion module became active and the appropriate LCD message displayed.</p>
2133 ID 1 to 4 Analogue Input A to H High	<p>▲ NOTE: Due to module configuration the alarm message that appears on the display may be different. For further details of module configuration, refer to DSE Publication: 057-257 DSE8660 MKII Configuration Suite PC Software Manual.</p> <p>The module detected that an analogue input value of a DSE2133 had risen above the <i>Flexible Sensor High Pre-Alarm Trip</i> level.</p>
2133 ID 1 to 4 Analogue Input A to H Low	<p>▲ NOTE: Due to module configuration the alarm message that appears on the display may be different. For further details of module configuration, refer to DSE Publication: 057-257 DSE8660 MKII Configuration Suite PC Software Manual.</p> <p>The module detected that an analogue input value of a DSE2133 had fallen below the <i>Flexible Sensor Low Pre-Alarm Trip</i> level.</p>
Battery Detect Failure	The module detected that a battery charger connected by DSENet [®] had issued a <i>Battery Detect Failure</i> alarm.
Battery Failure Detection Output 1	The module detected that a battery charger connected by DSENet [®] had issued a <i>Battery Failure Detection</i> alarm on its Output 1.
Battery Failure Detection Output 2	The module detected that a battery charger connected by DSENet [®] had issued a <i>Battery Failure Detection</i> alarm on its Output 2.
Battery High Current Output 1	The module detected that a battery charger connected by DSENet [®] had issued a <i>Battery High Current</i> alarm on its Output 1.
Battery High Current Output 2	The module detected that a battery charger connected by DSENet [®] had issued a <i>Battery High Current</i> alarm on its Output 2.
Battery High Temperature Output 1	The module detected that a battery charger connected by DSENet [®] had issued a <i>Battery High Temperature</i> alarm on its Output 1.
Battery High Temperature Output 2	The module detected that a battery charger connected by DSENet [®] had issued a <i>Battery High Temperature</i> alarm on its Output 2.
Battery High Voltage IEEE 37.2 – 59 DC Overvoltage Relay	The module detected that its DC supply voltage had risen above the <i>Plant Battery Overvolts Warning Trip</i> level for the configured delay timer.
Battery High Voltage Output 1	The module detected that a battery charger connected by DSENet [®] had issued a <i>Battery High Voltage</i> alarm on its Output 1.
Battery High Voltage Output 2	The module detected that a battery charger connected by DSENet [®] had issued a <i>Battery High Voltage</i> alarm on its Output 2.

Continued over page...

Protections

Fault	Description
Battery Low Voltage IEEE 37.2 – 27 DC Undervoltage Relay	The module detected that its DC supply voltage had fallen below the <i>Plant Battery Undervolts Warning Trip</i> level for the configured delay timer.
Battery Low Voltage Output 1	The module detected that a battery charger connected by DSENet® had issued a <i>Battery Low Voltage</i> alarm on its Output 1.
Battery Low Voltage Output 2	The module detected that a battery charger connected by DSENet® had issued a <i>Battery Low Voltage</i> alarm on its Output 2.
Battery Temperature Sensor Fail Output 1	The module detected that a battery charger connected by DSENet® had issued a <i>Battery Temperature Fail</i> alarm on its Output 1.
Battery Temperature Sensor Fail Output 2	The module detected that a battery charger connected by DSENet® had issued a <i>Battery Temperature Fail</i> alarm on its Output 2.
Bus Asymmetry High	The module detected the bus voltage asymmetry had risen above the configurable <i>Trip</i> level for the configured delay timer.
Bus Over Negative Sequence	The module detected the bus voltage negative sequence had risen above the configurable <i>Trip</i> level for the configured delay timer.
Bus Over Zero Sequence	The module detected the bus voltage zero sequence had risen above the configurable <i>Trip</i> level for the configured delay timer.
Bus Under Positive Sequence	The module detected the bus voltage positive sequence had fallen below the configurable <i>Trip</i> level for the configured delay timer.
Calibration Fault	The module detected that its internal calibration has failed. The unit must be sent back to DSE to be investigated and repaired. Contact DSE Technical Support for more details.
Charger Fan Locked	The module detected that a battery charger connected by DSENet® had a <i>Charger Failure</i> alarm.
Charger High Temperature	The module detected that a battery charger connected by DSENet® had a High Temperature alarm.
Charger Mains High Current	The module detected that a battery charger connected by DSENet® had a <i>Mains High Current</i> alarm.
Charger ID 0 to 3 Common Warning	 NOTE: Due to module configuration the alarm message that appears on the display may be different. For further details of module configuration, refer to DSE Publication: 057-257 DSE8660 MKII Configuration Suite Software Manual.
	The module detected that a battery charger connected by DSENet® had issued a <i>Common Warning Alarm</i> .
Charger Mains High Voltage	The module detected that a battery charger connected by DSENet® had a <i>Mains High Voltage</i> alarm.
Charger Mains Low Voltage	The module detected that a battery charger connected by DSENet® had a <i>Mains Low Voltage</i> alarm.
Charger Voltage Drop Charging Cable Output 1	The module detected that a battery charger connected by DSENet® had issued a <i>Voltage Drop Charging Cable</i> alarm on its Output 1.
Charger Voltage Drop Charging Cable Output 2	The module detected that a battery charger connected by DSENet® had issued a <i>Voltage Drop Charging Cable</i> alarm on its Output 2.
Digital Input A to L	 NOTE: Due to module configuration the alarm message that appears on the display may be different. For further details of module configuration, refer to DSE Publication: 057-257 DSE8660 MKII Configuration Suite PC Software Manual.
	The module detected that a digital input configured to create a fault condition became active and the appropriate LCD message is displayed.
Exp. Unit Failure	The module detected that communications to one of the DSENet® expansion modules had been lost.

Continued over page...

Fault	Description
Fail To Sync	If the module cannot synchronise within the time allowed by the Synchronising timer a warning is initiated. The LCD indicates <i>Failed To Sync</i> .
FRT event	<div style="border: 1px solid black; padding: 5px; margin-bottom: 5px;">  NOTE: For more details, see section entitled <i>Fault Ride Through</i> elsewhere in this document. </div> <p>The module activated the <i>Fault Ride Through</i> event</p>
Insufficient Capacity	If the generator bus reaches full load when they are in parallel with the mains. The LCD indicates <i>Insufficient Capacity</i> .
Mains Asymmetry High	The module detected the mains voltage asymmetry had risen above the configurable <i>Trip</i> level for the configured delay timer.
Mains Decoupling High Frequency	If the module detects the mains frequency increase when in parallel with the generator(s) more then the configure value. The LCD indicates <i>Mains Decoupling High Frequency</i> .
Mains Decoupling High Voltage	If the module detects the mains voltage increase when in parallel with the generator(s) more then the configure value. The LCD indicates <i>Mains Decoupling High Voltage</i> .
Mains Decoupling Low Frequency	If the module detects the mains frequency decreases when in parallel with the generator(s) below the configure value. The LCD indicates <i>Mains Decoupling Low Frequency</i> .
Mains Decoupling Low Voltage	If the module detects the mains voltage decreases when in parallel with the generator(s) below the configure value. The LCD indicates <i>Mains Decoupling Low Voltage</i> .
Mains Decoupling ROCOF	If the module detects the mains frequency changing when in parallel with the generator(s) more then the configure value in a time frame. The LCD indicates <i>Mains Decoupling ROCOF</i> .
Mains Decoupling Vector Shift	If the module detects the mains phase angle changing when in parallel with the generator(s) more then the configure value in a time frame. The LCD indicates <i>Mains Decoupling Vector Shift</i> .
Mains Failed To Close	If the mains breaker fails to close, a warning is initiated. The LCD indicates <i>Mains Failed To Close</i> .
Mains Failed To Open	If the mains breaker fails to open, a warning is initiated. The LCD indicates <i>Mains Failed To Open</i> .
Mains Over Negative Sequence	The module detected the mains voltage negative sequence had risen above the configurable <i>Trip</i> level for the configured delay timer.
Mains Over Zero Sequence	The module detected the mains voltage zero sequence had risen above the configurable <i>Trip</i> level for the configured delay timer.
Mains Reverse Power <small>IEEE C37.2 – 32 Directional Power Relay</small>	If the module detects that the generator bus is exporting more than the configured limit, the LCD indicates <i>Mains Reverse Power</i>
Mains Under Positive Sequence	The module detected the mains voltage positive sequence had fallen below the configurable <i>Trip</i> level for the configured delay timer.
MSC Alarms Inhibited	The module detected that an input configured for <i>MSC Alarms Inhibit</i> had become active disabling all the MSC alarms.
MSC 1 and 2 Failure	That module detected that the MSC and Redudant MSC communication failed, most likely caused by it being disconnected.
MSC 1 Data Error	The module detected that data on the MSC link had become corrupt, possibly caused by incorrect wiring or faulty cabling.
MSC 1 Link Failure	That module detected that the MSC communication failed, most likely caused by it being disconnected.
MSC 1 Too Few Sets	That module detected that the number of modules on the MSC was less then the configured <i>Minimum Modules on MSC Link</i> setting.

Continued over page...

Protections

Fault	Description
MSC 2 Data Error	The module detected that data on the Redundant MSC link had become corrupt, possibly caused by incorrect wiring or faulty cabling.
MSC 2 Link Failure	That module detected that the Redudant MSC communication failed, most likely caused by it being disconnected.
MSC 2 Too Few Sets	That module detected that the number of modules on the Redundant MSC was less then the configured Minimum Modules on MSC Link setting.

6.4 ELECTRICAL TRIP ALARMS

NOTE: The fault condition must be resolved before the alarm can be reset. If the fault condition remains, it is not possible to reset the alarm (the exception to this is the *Coolant Temp High* alarm and similar *Active From Safety On* alarms, as the coolant temperature could be high with the engine at rest).

Electrical Trip alarms are latching and stop the generator bus but in a controlled manner. On initiation of the Electrical Trip condition the module de-energises all the **Close Bus** output to remove the load from the generator bus. Once this has occurred the module removes the start request on the MSC link.

Example:

1/2 Alarms
 Bus Failed to Close
 Electrical Trip

In the event of an alarm the LCD jumps to the alarms page and scrolls through all active alarms.

Electrical Trip Alarms are latching alarms and to remove the fault, press the **Stop/Reset Mode**  button on the module.

Fault	Description
2130 ID 1 to 4 Analogue Input E to H High	<p>NOTE: Due to module configuration the alarm message that appears on the display may be different. For further details of module configuration, refer to DSE Publication: <i>057-257 DSE8660 MKII Configuration Suite PC Software Manual</i>.</p> <p>The module detected that an analogue input value of a DSE2130 had risen above the <i>Flexible Sensor High Alarm Trip</i> level.</p>
2130 ID 1 to 4 Analogue Input E to H Low	<p>NOTE: Due to module configuration the alarm message that appears on the display may be different. For further details of module configuration, refer to DSE Publication: <i>057-257 DSE8660 MKII Configuration Suite PC Software Manual</i>.</p> <p>The module detected that an analogue input value of a DSE2130 had fallen below the <i>Flexible Sensor Low Alarm Trip</i> level.</p>
2130 ID1 to 4 Digital Input A to H	<p>NOTE: Due to module configuration the alarm message that appears on the display may be different. For further details of module configuration, refer to DSE Publication: <i>057-257 DSE8660 MKII Configuration Suite PC Software Manual</i>.</p> <p>The module detected that a digital input configured to create a fault condition on a DSE2130 expansion module became active and the appropriate LCD message displayed.</p>

Continued over page...

Fault	Description
2131 ID 1 to 4 Analogue Input A to J High	<p>▲ NOTE: Due to module configuration the alarm message that appears on the display may be different. For further details of module configuration, refer to DSE Publication: 057-257 DSE8660 MKII Configuration Suite PC Software Manual.</p> <p>The module detected that an analogue input value of a DSE2131 had risen above the <i>Flexible Sensor High Alarm Trip</i> level.</p>
2131 ID 1 to 4 Analogue Input A to J Low	<p>▲ NOTE: Due to module configuration the alarm message that appears on the display may be different. For further details of module configuration, refer to DSE Publication: 057-257 DSE8660 MKII Configuration Suite PC Software Manual.</p> <p>The module detected that an analogue input value of a DSE2131 had fallen below the <i>Flexible Sensor Low Alarm Trip</i> level.</p>
2131 ID1 to 4 Digital Input A to J	<p>▲ NOTE: Due to module configuration the alarm message that appears on the display may be different. For further details of module configuration, refer to DSE Publication: 057-257 DSE8660 MKII Configuration Suite PC Software Manual.</p> <p>The module detected that a digital input configured to create a fault condition on a DSE2131 expansion module became active and the appropriate LCD message displayed.</p>
2133 ID 1 to 4 Analogue Input A to H High	<p>▲ NOTE: Due to module configuration the alarm message that appears on the display may be different. For further details of module configuration, refer to DSE Publication: 057-257 DSE8660 MKII Configuration Suite PC Software Manual.</p> <p>The module detected that an analogue input value of a DSE2133 had risen above the <i>Flexible Sensor High Alarm Trip</i> level.</p>
2133 ID 1 to 4 Analogue Input A to H Low	<p>▲ NOTE: Due to module configuration the alarm message that appears on the display may be different. For further details of module configuration, refer to DSE Publication: 057-257 DSE8660 MKII Configuration Suite PC Software Manual.</p> <p>The module detected that an analogue input value of a DSE2133 had fallen below the <i>Flexible Sensor Low Alarm Trip</i> level.</p>
Bus Asymmetry High	The module detected the bus voltage asymmetry had risen above the configurable <i>Trip</i> level for the configured delay timer.
Bus Failed To Close	If the bus breaker fails to close, the LCD indicates <i>Bus Failed To Close</i> .
Bus Failed To Open	If the bus breaker fails to open, the LCD indicates <i>Bus Failed To Open</i> .
Bus Over Negative Sequence	The module detected the bus voltage negative sequence had risen above the configurable <i>Trip</i> level for the configured delay timer.
Bus Over Zero Sequence	The module detected the bus voltage zero sequence had risen above the configurable <i>Trip</i> level for the configured delay timer.
Bus Phase Sequence	The module detected a bus phase rotation error, an electrical trip is initiated. The LCD indicates <i>Bus Phase Seq Wrong</i> .

Continued over page...

Fault	Description
Bus Under Positive Sequence	The module detected the bus voltage positive sequence had fallen below the configurable <i>Trip</i> level for the configured delay timer.
Calibration Fault	The module detected that its internal calibration has failed. The unit must be sent back to DSE to be investigated and repaired. Contact DSE Technical Support for more details.
Charger ID 0 to 3 Common Electrical Trip	<p>▲ NOTE: Due to module configuration the alarm message that appears on the display may be different. For further details of module configuration, refer to DSE Publication: 057-257 DSE8660 MKII Configuration Suite Software Manual.</p>
	The module detected that a battery charger connected by DSENet® had issued a <i>Common Electrical Trip Alarm</i> .
Charger Failure	The module detected that a battery charger connected by DSENet® had a <i>Charger Failure</i> alarm.
Charger Fan Locked	The module detected that a battery charger connected by DSENet® had a <i>Charger Failure</i> alarm.
Charger High Temperature	The module detected that a battery charger connected by DSENet® had a <i>High Temperature</i> alarm.
Charger Input Fuse Fail	The module detected that a battery charger connected by DSENet® had an <i>Input Fuse Fail</i> alarm.
Charger Mains High Current	The module detected that a battery charger connected by DSENet® had a <i>Mains High Current</i> alarm.
Charger Mains High Voltage	The module detected that a battery charger connected by DSENet® had a <i>Mains High Voltage</i> alarm.
Charger Mains Low Voltage	The module detected that a battery charger connected by DSENet® had a <i>Mains Low Voltage</i> alarm.
Charger Reverse Polarity	The module detected that a battery charger connected by DSENet® had a <i>Reverse Polarity</i> alarm.
Charger Short Circuit	The module detected that a battery charger connected by DSENet® had a <i>Short Circuit</i> alarm.
Charger Short Circuit / Reverse Polarity	The module detected that a battery charger connected by DSENet® had a combined <i>Short Circuit</i> and <i>Reverse Polarity</i> alarm.
Combined Mains Decoupling	The module detected that the mains supply failed when the generator was in parallel with it.
Digital Input A to L	<p>▲ NOTE: Due to module configuration the alarm message that appears on the display may be different. For further details of module configuration, refer to DSE Publication: 057-257 DSE8660 MKII Configuration Suite Software Manual.</p>
	The module detected that a digital input configured to create a fault condition became active and the appropriate LCD message is displayed.
Exp. Unit Failure	The module detected that communications to one of the DSENet® expansion modules had been lost.
Fail to Synchronise	The module failed to synchronise the generator before the <i>Fail to Sync Delay</i> timer had expired.
Insufficient Capacity	The module's governor output has reached its limit whilst attempting to control the generator to produce more kW's whilst in parallel. This indicates a fault with either the governor (including connection error), setting of SW2, or that the engine has reached its maximum capacity.
Mains Asymmetry High	The module detected the mains voltage asymmetry had risen above the configurable <i>Trip</i> level for the configured delay timer.

Continued over page...

Protections

Fault	Description
Mains Decoupling OF	The module detected that the mains frequency had risen above the <i>Mains Decoupling Over Frequency Trip</i> level when the generator was in parallel with the mains.
Mains Decoupling OV	The module detected that the mains voltage had risen above the <i>Mains Decoupling Over Voltage Trip</i> level when the generator was in parallel with the mains.
Mains Decoupling UF	The module detected that the mains frequency had fallen below the <i>Mains Decoupling Under Frequency Trip</i> level when the generator was in parallel with the mains.
Mains Decoupling UV	The module detected that the mains voltage had risen above the <i>Mains Decoupling Under Voltage Trip</i> level when the generator was in parallel with the mains.
Mains Over Negative Sequence	The module detected the mains voltage negative sequence had risen above the configurable <i>Trip</i> level for the configured delay timer.
Mains Over Zero Sequence	The module detected the mains voltage zero sequence had risen above the configurable <i>Trip</i> level for the configured delay timer.
Mains Phase Sequence Wrong	The module detected a mains phase rotation error, an electrical trip is initiated. The LCD indicates <i>Mains Phase Seq Wrong</i> .
Mains Reverse Power IEEE C37.2 – 32 Directional Power Relay	The module detected that the generator bus is exporting more than the configured limit, the LCD indicates <i>Mains Reverse Power</i>
Mains ROCOF	The module detected that the mains frequency had changed at a rate larger than the <i>Mains ROCOF Alarm Trip</i> level when the generator was in parallel with the mains.
Mains Under Positive Sequence	The module detected the mains voltage positive sequence had fallen below the configurable <i>Trip</i> level for the configured delay timer.
Mains Vector Shift	The module detected that the mains voltage waveform's vector had shifted more than the <i>Mains Vector Shift Alarm Trip</i> level when the generator was in parallel with the mains.
MSC ID Error	The module detected that another module on the MSC link had the same <i>GenSet MSC ID</i> configured.
MSC Old Version Unit	The module detected that another module on the MSC link was incompatible. Check all the module firmware version numbers (under <i>About Application Number</i> on the modules' displays) and ensure all are the latest version firmware. Use the DSE Configuration Suite Software to upgrade the firmware (<i>Tools Update Firmware</i>) of the older modules.
MSC 1 and 2 Failure	That module detected that the MSC and Redundant MSC communication failed, most likely caused by it being disconnected.
MSC 1 Link Failure	That module detected that the MSC communication failed, most likely caused by it being disconnected.
MSC 1 Too Few Sets	That module detected that the number of modules on the MSC was less than the configured <i>Minimum Modules on MSC Link</i> setting.
MSC 2 Link Failure	That module detected that the Redundant MSC communication failed, most likely caused by it being disconnected.
MSC 2 Too Few Sets	That module detected that the number of modules on the Redundant MSC was less than the configured <i>Minimum Modules on MSC Link</i> setting.
Out Of Sync Bus	 NOTE: For further details, refer to DSE Publication: 056-047 Out of Sync and Failed to Close Training Document.
	If the module detects that the generator bus supply is not sync when the breaker is closed. The LCD indicates <i>Out Of Sync Bus</i> .

Continued over page...

Protections



Fault	Description
Out of Sync Mains	<p> NOTE: For further details, refer to DSE Publication: 056-047 Out of Sync and Failed to Close Training Document.</p> <p>If the module detects that the mains supply is not sync when the breaker is closed. The LCD indicates <i>Out Of Sync Mains</i>.</p>
Priority Selection Error	<p>If the module detects that another DSE8660 MKII or DSE8680 shares the same priority number, an electrical trip is initiated. The LCD indicates <i>Priority Selection Error</i>.</p>

6.5 MAINS DECOUPLING ALARMS

 **NOTE: These protections only operate only when the mains and generator bus are in parallel, it is disabled at all other times.**

When the mains (utility) and the generator bus supplies are in parallel, the module monitors for a Mains failure by detecting ROCOF or Vector Shift fault which are set in the module's configuration.



Should either of these alarms operate, the module performs an electrical trip of the common generator bus or a mains failure. This operation must be manually reset by:







- Pressing the **Stop/Reset Mode**  button. The generator bus load switch opens and the generator start request is removed if it is still running and the alarm is cleared.
- Activation of a digital input configured to **Clear Mains Decoupling Alarms** if it has been configured.
- Pressing the **Alarm Mute/Lamp Test**  and **Tick**  buttons together for a small duration.

6.6 OUT OF SYNC MAINS

An *Out of Sync Mains* alarm means that the DSE8x60 module has detected that the supplies either side of the mains breaker are not in sync when the mains breaker should be closed. This is normally caused by the mains load switching device not closing quickly enough or not at all.

Should the alarms activate, the module performs an electrical trip of the mains load switch and causes a mains failure event. This operation must be manually reset by:



- Pressing the **Stop/Reset Mode**  button. The generator bus load switch opens and the generator start request is removed if it is still running and the alarm is cleared.
- Activation of a digital input configured to **Alarm Reset** if it has been configured.
- To clear the *Out of Sync Mains* alarm without pressing the **Stop/Reset Mode**  button or activating a digital input configured for *Alarm Reset*.

- Press and hold the **Tick**  button to enter the 'running' configuration editor.
- Press the **Instrumentation Scroll**  buttons to cycle to the **Auxiliary Mains Fail / Out Of Sync Reset** parameter.
- Press the **Tick**  button to edit the parameter. The parameter begins to flash to indicate that the parameter is being edited.
- Press the **Instrumentation Scroll**  buttons to adjust the parameter to **Active**.
- Press the **Tick**  button to stop editing the parameter. The parameter ceases flashing to indicate that the parameter is no longer being edited.
- Press and hold the **Tick**  button to exit the 'running' configuration editor.

6.7 MAINS SEQUENCE ALARMS

When the mains (utility) is available, the DSE8x60 module monitors the mains supply to detect a *Mains Asymmetry High*, or *Mains Over Negative Sequence*, or *Mains Zero Over Sequence*, or *Mains Under Positive Sequence* fault which are set in the module's configuration.

Should any of these alarms operate, the module performs an electrical trip of the mains load switch and causes a mains failure event. This operation must be manually reset by:

- Pressing the **Stop/Reset Mode**  button. The generator bus load switch opens and the generator start request is removed if it is still running and the alarm is cleared.
- Activation of a digital input configured to **Alarm Reset** if it has been configured.
- To clear the *Mains Sequence* alarm without pressing the **Stop/Reset Mode**  button or activating a digital input configured for *Alarm Reset*.

- Press and hold the **Tick**  button to enter the 'running' configuration editor.

- Press the **Instrumentation Scroll**  buttons to cycle to the **Auxiliary Mains Fail Sequence Alarm Reset** parameter.

- Press the **Tick**  button to edit the parameter. The parameter begins to flash to indicate that the parameter is being edited.

- Press the **Instrumentation Scroll**  buttons to adjust the parameter to **Active**.

- Press the **Tick**  button to stop editing the parameter. The parameter ceases flashing to indicate that the parameter is no longer being edited.

- Press and hold the **Tick**  button to exit the 'running' configuration editor.

6.8 FAULT RIDE THROUGH

CAUTION! Care **MUST** be taken during configuration of the *Fault Ride Through* function as prolonged time in parallel with a failed mains might cause a substantial damage to the generators. For guidance on how to configure the *Fault Ride Through* function, refer to the relevant standards for paralleling with the mains.

NOTE: Depending on module configuration, *Fault Ride Through* function operates when the generators are in parallel with the mains or when they are running in island. For further details of module configuration, refer to DSE Publication: **057-257 DSE8660 MKII Configuration Suite PC Software Manual.**

The *Fault Ride Through* function is applicable for generators in parallel with the mains and generators that are paralleling with each other to supply critical power distribution networks. The *Fault Ride Through* function prevents the generators bus disconnecting from the grid if the voltage momentarily decreases due to faults on the distribution network. This is achieved by using a curve that is formed from a sequence of *Connection Point Voltages* which increase at consecutive time intervals. This is done to enable the network voltage to recover over time after a fault has occurred and been cleared. If the generators bus (and others) were to trip during a momentary fault, after the fault cleared the amount of available power may not be enough to supply the demand. This would cause further protections to activate (such as under frequency) resulting in more generation tripping, leading to a power outage.

When the *Fault Ride Through* function is enabled and the mains voltage falls below the *Urec3* level, the *FRT Event* alarm activates to indicate a *Fault Ride Through* event is active. During a *Fault Ride Through* event the *Mains Low Voltage* alarm conditions are ignored as long as the voltage level stays above the *Fault Ride Through* curve (within the *Acceptable Voltage Region*). If the voltage falls below the curve, the module activates the *Mains Low Voltage* alarm after the *Mains Transient Delay* time has expired. The *Fault Ride Through* event is cleared when the *Trec4* timer expires and the voltage rises above the *Urec3* level. If the voltage does not rise above *Urec3* when the *Trec4* time expires, the *FRT Event* alarm remains active and does not clear. During this period all the alarms are no longer ignored until the voltage raises above the *Urec3* and another *FRT event* condition occurs.

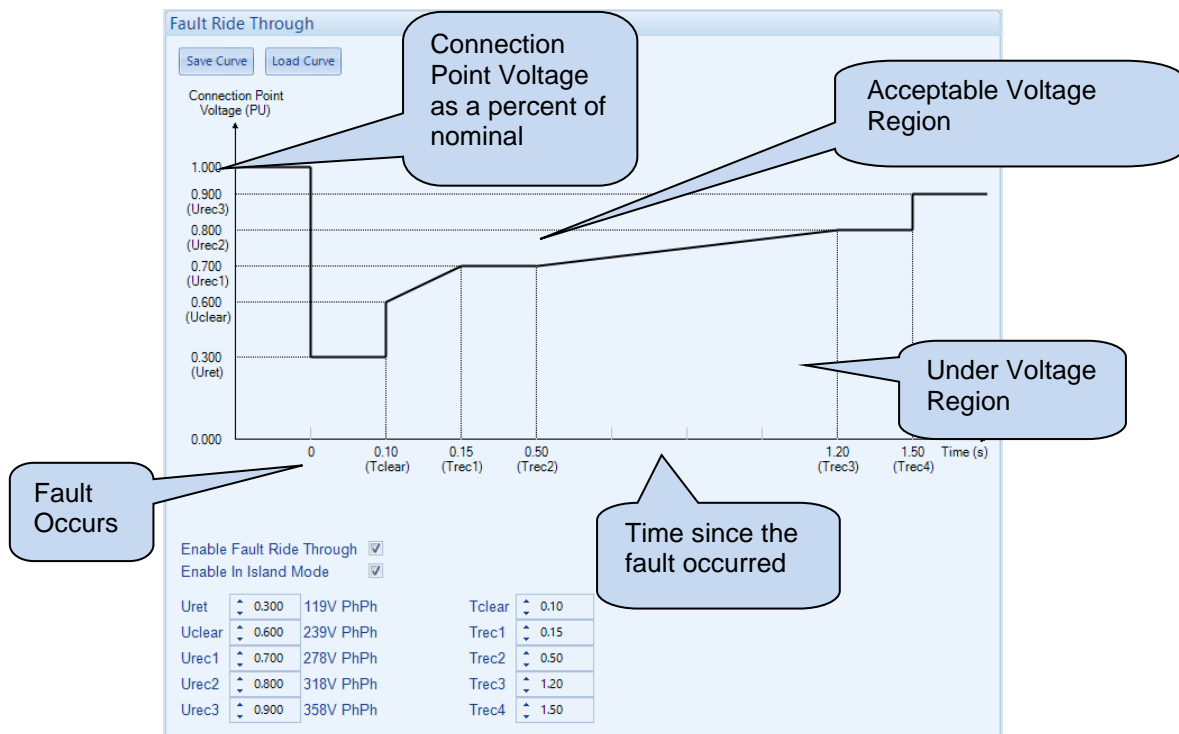

Protections

The *Connection Point Voltages* (*Uret, Uclear, Urec1, Urec2, Urec3*) and time intervals (*Tclear, Trec1, Trec2, Trec3, Trec4*) are configured in the *Fault Ride Through* section of the module's configuration. For guidance on how to configure these settings, refer to the relevant standards for *Fault Ride Through* protection which are normally governed by mains parallel standards.

When the *Fault Ride Through* function activates, the following *Auxiliary Mains Fail* and *Electrical Trip* alarms are also ignored to prevent the generators bus tripping:

- *Under Voltage*
- *Over Voltage*
- *Under Frequency*
- *Over Frequency*
- *Mains Decoupling Voltage & Frequency Stage Alarms*
- *Voltage Symmetry*
- *Zero Sequence*
- *Negative Sequence*
- *Positive Sequence*
- *Phase Rotation*

The *Warning* alarms are NOT ignored during the *Fault Ride Through* event.

The module records of the number of times the *Fault Ride Through* event has occurred with an inbuilt counter. The module increments this counter everytime it activates the *Fault Ride Through* feature. This counter is accessed using the SCADA section of the DSE Configuration Suite Software, under the *Bus* section's *Fault Ride Through*. The *Fault Ride Through Events* counter is resetable from the *Accumulated Instrumentation* in the SCADA's *Maintenance* section.

Mains			
Frequency			
50.01 Hz			
Phase Rotation			
L1-L2-L3			
Phase To Neutral Voltages			
L1 - N	L2 - N	L3 - N	
226.3 V	226.4 V	226.3 V	
Phase To Phase Voltages			
L1 - L2	L2 - L3	L3 - L1	
391.7 V	392.1 V	392.1 V	
Mains Current			
L1	L2	L3	
82.0 A	84.0 A	87.0 A	
Fault Ride Through			
27 Events			

7 FRONT PANEL CONFIGURATION

This configuration mode allows the operator to fully configure the module through its display without the use of the DSE Configuration Suite PC Software.

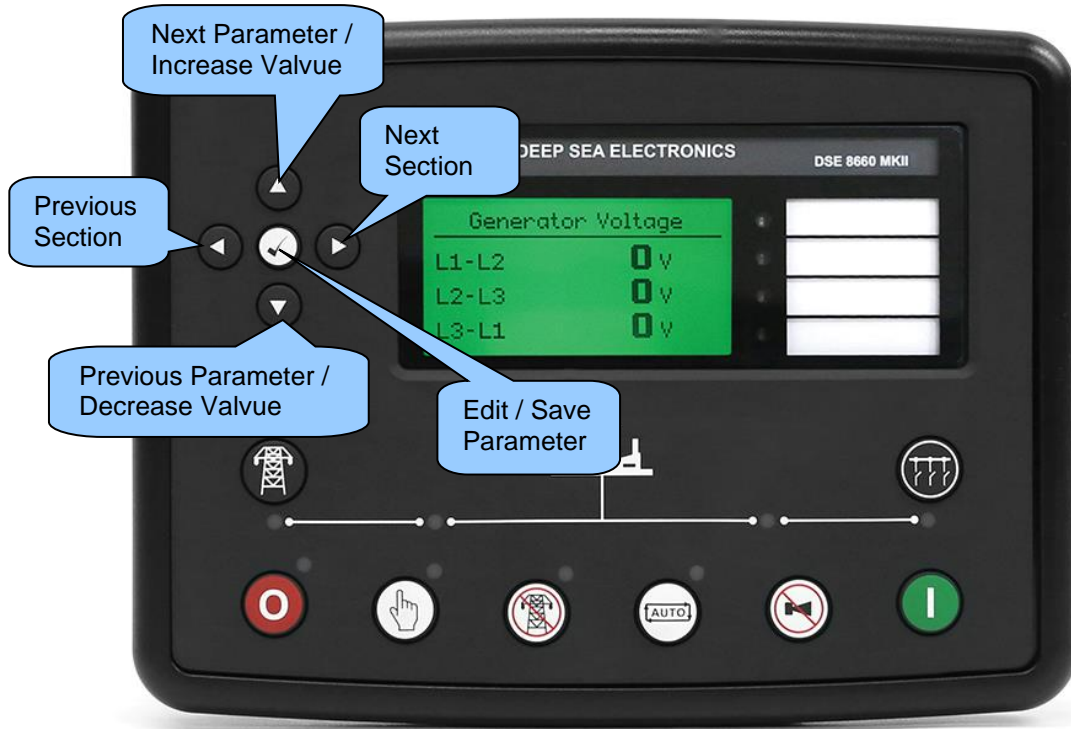

Use the module's facia buttons to traverse the menu and make value changes to the parameters:



7.1 MAIN CONFIGURATION EDITOR

7.1.1 ACCESSING THE MAIN CONFIGURATION EDITOR

NOTE: More comprehensive module configuration is possible via PC configuration software. For further details of module configuration, refer to DSE Publication: *057- 257 DSE8660 MKII Configuration Suite PC Software Manual*.



- Ensure the generator bus is at rest and the module is in *Stop Mode* by pressing the **Stop/Reset Mode**  button.
- Press the **Stop/Reset Mode**  and **Tick**  buttons together to enter the *Main Configuration Editor*.

7.1.2 ENTERING PIN

NOTE: The PIN is not set by DSE when the module leaves the factory. If the module has a PIN code set, the generator supplier has entered this. Contact the generator supplier if the code is required. If the code has been 'lost' or 'forgotten', the module must be returned to the DSE factory to have the PIN removed. A charge is made for this procedure. This procedure cannot be performed away from the DSE factory.

NOTE: The PIN is automatically reset when the editor is exited (manually or automatically) to ensure security.

- If a module security PIN has been set, the PIN request is then shown.

- Press the **Tick**  button, the first '#' changes to '0'. Press the **Up** or **Down**  buttons to adjust it to the correct value.

- Press the **Right**  button when the first digit is correctly entered. The digit previously entered now shows as '#' for security.





- Repeat this process for the other digits of the PIN number. Press the **Left**  button to move back to adjust one of the previous digits.

- When the **Tick**  button is pressed after editing the final PIN digit, the PIN is checked for validity. If the number is not correct, the PIN must be re-entered.

- If the PIN has been successfully entered (or the module PIN has not been enabled), the editor is displayed.



7.1.3 EDITING A PARAMETER

 **NOTE:** Pressing and holding the *Menu Navigation*  buttons provides the auto-repeat functionality. Values can be changed quickly by holding the navigation buttons for a prolonged period of time.

- Press the **Right** or **Left**  buttons to cycle to the section to view/change.
- Press the **Up** or **Down**  buttons to select the parameter to view/change within the currently selected section.
- To edit the parameter, press the **Tick**  button to enter edit mode. The parameter begins to flash to indicate editing.
- Press the **Up** or **Down**  buttons to change the parameter to the required value.
- Press the **Tick**  button to save the value. The parameter ceases flashing to indicate that it has been saved.

7.1.4 EXITING THE MAIN CONFIGURATION EDITOR

 **NOTE:** The editor automatically exits after 5 minutes of inactivity to ensure security.



- Press and hold the **Stop/Reset Mode**  button to exit the editor without saving changes.
- Press and hold the **Tick**  button to exit the editor and save the changes.

7.1.5 ADJUSTABLE PARAMETERS

Section	Parameter As Shown On Display	Values
Display	Contrast	0%
	Language	English, Other.
	Current Date and Time	DD:MM:YY, hh:mm:ss
Timers	LCD Page Timer	0 h 0 m 0 s
	Scroll Delay	0 h 0 m 0 s
	Battery Under Voltage Warning Delay	0 h 0 m 0 s
	Battery Over Voltage Warning Delay	0 h 0 m 0 s
	Start Delay Off Load	0 h 0 m 0 s
	Start Delay On Load	0 h 0 m 0 s
	Start Delay Telemetry	0 h 0 m 0 s
	Start Delay Mains Fail	0 h 0 m 0 s
	Mains Transient Delay	0.0 s
	Return Delay	0 h 0 m 0 s
	Mains Transfer Time	0 m 0.0 s
	Mains Over Zero Seq Volt Delay	0.0 s
	Mains Under Pos Seq Volt Delay	0.0 s
	Mains Over Neg Seq Volts Delay	0.0 s
	Mains Asymmetry High Delay	0.0 s
	Bus Over Zero Seq Volts Delay	0.0 s
	Bus Under Pos Seq Volts Delay	0.0 s
	Bus Over Neg Seq Volts Delay	0.0 s
	Bus Asymmetry High Delay	0.0 s
	Mains	Under Voltage Trip
Over Voltage Trip		0 V
Under Frequency Trip		0.0 Hz
Over Frequency Trip		0.0 Hz
CT Primary		0 A Power Cycle After Exit
CT Secondary		0 A Power Cycle After Exit
Mains Rating		0 kW
Mains Rating		0 kvar
Mains Over Zero Seq Volt		Active / Inactive
Mains Over Zero Seq Volt		0.0 V
Mains Under Pos Seq Volt		Active / Inactive
Mains Under Pos Seq Volt		0.0 V
Mains Over Neg Seq Volts		Active / Inactive
Mains Over Neg Seq Volts		0.0 V
Mains Asymmetry High		Active / Inactive
Mains Asymmetry High		0.0 V
AC System		3 Phase, 4 Wire
Bus		Start Delay On Load
	Battery Under Voltage Warning	Active / Inactive
	Battery Under Voltage Warning Delay	0 h 0 m 0 s
	Battery Under Voltage Warning	0.0 V
	Battery Over Voltage Warning	Active / Inactive
	Battery Over Voltage Warning Delay	0 h 0 m 0 s
	Battery Over Voltage Warning	0.0 V
	Load Level For More Sets	0 %
	Load Level For Less Sets	0 %
	Ramp Up Rate	0.0 %
	Ramp Down Rate	0.0 %
	Bus Over Zero Seq Volts	Active / Inactive
	Bus Over Zero Seq Volts	0.0 V
	Bus Under Pos Seq Volts	Active / Inactive

Continued over page...

Front Panel Configuration

Section	Parameter As Shown On Display	Values
Bus (Continued)	Bus Under Pos Seq Volts	0.0 V
	Bus Over Neg Seq Volts	Active / Inactive
	Bus Over Neg Seq Volts	0.0 V
	Bus Asymmetry High	Active / Inactive
	Bus Asymmetry High	0.0 V
	Enable MSC Compatibility	Active / Inactive
Communications	RS232 Port Baud Rate	1200 / 2400 / 4800 / 9600 / 14400 / 19200 / 28800 / 38400 / 57600 / 115200
	RS232 Port Slave ID	1
	RS485 Port Baud Rate	1200 / 2400 / 4800 / 9600 / 14400 / 19200 / 28800 / 38400 / 57600 / 115200
	RS485 Port Slave ID	1
Schedule	Schedule	Active / Inactive
	Schedule Bank 1 Period	Weekly / Monthly,
	Island / Parallel / Off Load / Auto Start Inhibit, Week, Start Time, Run Time and Day. Selection (1 to 8)	Press  to begin editing then up or down when selecting the different parameters.
	Schedule Bank 2 Period	Weekly / Monthly,
	Island / Parallel / Off Load / Auto Start Inhibit, Week, Start Time, Run Time and Day. Selection (1 to 8)	Press  to begin editing then up or down when selecting the different parameters.

7.2 'RUNNING' CONFIGURATION EDITOR

7.2.1 ACCESSING THE 'RUNNING' CONFIGURATION EDITOR



- The *'Running' Configuration Editor* is accessible without stopping the engine. All protections remain active whilst using the *'Running' Configuration Editor*.





- Press and hold the **Tick**  button to access the *'Running' Configuration Editor*.

7.2.2 ENTERING PIN

Even if a module security PIN has been set, the PIN is not requested whilst entering the *'Running' Configuration Editor*

7.2.3 EDITING A PARAMETER

 **NOTE:** Pressing and holding the *Menu Navigation*  buttons provides the auto-repeat functionality. Values can be changed quickly by holding the navigation buttons for a prolonged period of time.

- Press the **Right** or **Left**  buttons to cycle to the section to view/change.
- Press the **Up** or **Down**  buttons to select the parameter to view/change within the currently selected section.
- To edit the parameter, press the **Tick**  button to enter edit mode. The parameter begins to flash to indicate editing.
- Press the **Up** or **Down**  buttons to change the parameter to the required value.
- Press the **Tick**  button to save the value. The parameter ceases flashing to indicate that it has been saved.

7.2.4 EXITING THE 'RUNNING' CONFIGURATION EDITOR

 **NOTE: The editor automatically exits after 5 minutes of inactivity to ensure security.**



- Press and hold the **Tick** button to exit the editor and save the changes.

7.2.5 RUNNING EDITOR PARAMETERS

Section	Parameter As Shown On Display	Values
Display	Contrast	0 %
	Language	English, Other
	Commissioning Screens	Active / Inactive
	Mains Decoupling Test Mode	Active / Inactive
	Voltage and Frequency Injection Testing	Active / Inactive (Remains active for 3 minutes)
	Voltage Adjust (manual mode only, bus breaker open)	0 V
	Frequency Adjust (manual mode only, bus breaker open)	0 Hz
	Auxiliary Mains Fail / Out of Sync Reset	Active / Inactive
	Auxiliary Mains Fail Sequence Alarm Reset	Active / Inactive
Power Levels	Power Control Mode	Const Power / Frequency-Power / Voltage-Power
	kVAr Control Mode	Const Power Factor / Voltage-Reactive Power / Power-Power Factor / Const Reactive Power
	Load Parallel Power	0 %
	Load Parallel kVAr	0 %
	Load Parallel PF	0.00 pf

8 COMMISSIONING

8.1 BASIC CHECKS





Before the system is started, it is recommended that the following checks are made:

The unit is adequately cooled and all the wiring to the module is of a standard and rating compatible with the system. Check all mechanical parts are fitted correctly and that all electrical connections (including earths) are sound.

Check all mechanical parts are fitted correctly and that all electrical connections (including earths) are good. The unit **DC** supply is fused and connected to the battery and that it is of the correct polarity.

Check the operation of the MSC Link. Use the DSE Configuration Suite to check this in the *SCADA | BUS | MSC Link* page. Verify the number of *Set On The Bus* is equal to that of the number of DSE8x10 modules.

Ensure all DSE8x10 module in the system has been fully commissioned using the DSE “Four Steps to Successful Synchronising”. For more information, see section entitled *DSE 4 Steps to Successful Synchronising* else where in this manual.

Place the DSE8660 MKII module into **Stop/Reset Mode** . Place the DSE8x10 into **Auto Mode** . Initiate a start request by pressing the **Manual Mode**  followed by the **Start**  button on the DSE8660 MKII module. The DSE8x10 module starts upon receipt of the MSC start request. The generator bus remains off load so long as the mains supply is healthy and on load.

Place the DSE8660 MKII module into **Stop/Reset Mode** . The generator bus switch opens and the MSC start request is removed from the DSE8x10.

Set the modules internal clock/calendar to ensure correct operation of the scheduler and event logging functions. For details of this procedure, see section entitled *Front Panel Configuration*

If, despite repeated checking of the connections between the controller and the customer's system, satisfactory operation cannot be achieved, then the customer is requested to the DSE Technical Support Department

International Tel: +44 (0) 1723 890099
E-mail: support@deepseaelectronics.com
Website: www.deepseaelectronics.com

8.2 DSE 4 STEPS TO SUCCESSFUL SYNCHRONISING

 **NOTE: The DSE 4 Steps To Successful Synchronising must be performed on the load sharing controllers. Steps 1, 2, 3 & 4 are to be performed on every DSE8x10 in the system, whereas Steps 2, 3 & 4 are to be performed on every DSE8660 MKII controller.**

Synchronising and load sharing is often considered to be a complex subject. In fact, it is very simple when broken down into smaller steps.

After following the *Commissioning* section of this manual, the *DSE 4 Steps* **must** be followed before any parallel operation is attempted.

The following information covers the DSE 4 Steps to Successful Synchronising in full detail and must be completed on all generators in the system.

The full video presentation of the *4 Steps* is available on the DSE website. www.deepseaelectronics.com. Registration on the website is required. This is free of charge, along with all other downloads.

8.2.1 CONTROL (DSE8X10)

NOTE: Step 1 is only applicable to DSE8x10 controllers.

CAUTION! Failure to perform the *Control* steps results in poor control over the engine and alternator. This causes long and unstable synchronising as well as unstable kW and kvar load sharing.

NOTE: For further details of module configuration, refer to DSE Publication: *057-257 DSE8660 MKII Configuration Suite Software Manual*.

8.2.1.1 DETERMINING CONNECTIONS AND SETTINGS FOR GOVERNORS

Setting up the Governor (Adjustment of SW1 and SW2)

Before You Start

1. Ensure that the generator is connected to a **DEAD BUS BAR WITH NO LOADS** connected.
2. With the generator breaker open, set the generator to run at the **Nominal Frequency** without the DSE module connected to the Governor. To achieve this you will have to adjust the settings on the governor.
3. Connect the DSE module to the Governor once completed. The DSE controller connects only to the “-” and “IN” terminals and provides the varying DC voltage to simulate the turning of a potentiometer. The Analogue output terminals of the DSE controller are connected as follows. Note that the “+” terminal of the governor is left unconnected.

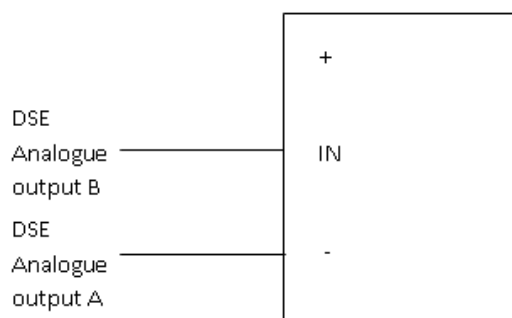

Adjustment of Governor SW1

4. Start the generator and ensure that the breaker is left open.
5. Check the direction of drive by increasing and decreasing SW1. If the frequency increases whilst SW1 is being decreased tick the option 'Output Reversed'. If moving SW1 does not change the frequency, check the wiring to the governor for faults.

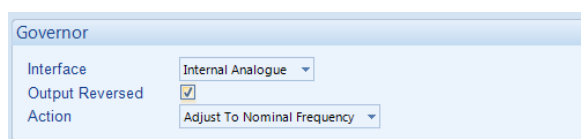

6. Adjust the SW1 setting for the Governor until the generator runs at **Nominal Frequency (50 Hz or 60 Hz)**
7. Stop the generator. SW1 is now complete and needs to be left alone.

Adjustment of Governor SW2

8. Increase the setting of the Nominal Frequency by **2.5 Hz** (52.5 Hz or 62.5 Hz)

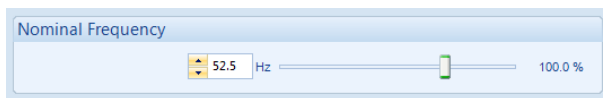

9. Start the generator. With the breaker open the generator will run at setting of SW1 (50 Hz or 60 Hz).
10. Close the generator breaker onto a **DEAD BUS BAR WITH NO LOADS** connected. The generator frequency shall start to increase towards the new Nominal Frequency setting (52.5 Hz or 62.5 Hz) however it may not achieve this.
11. Adjust SW2 to allow the frequency to increase to the new Nominal Frequency (52.5 Hz or 62.5 Hz)
12. Keep adjusting SW2 further to ensure Governor Drive reads within **75% to 85%**, the sign of the drive (+ or - percentage) does not matter.

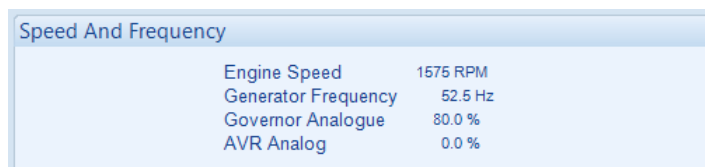

13. Stop the Generator
14. Decrease the setting of the Nominal Frequency by **2.5 Hz** (47.5 Hz or 57.5 Hz)

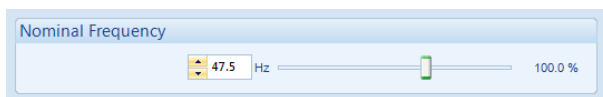

15. Start the generator. With the breaker open the generator will run at setting of SW1 (50 Hz or 60 Hz).
16. Close the generator breaker onto a **DEAD BUS BAR WITH NO LOADS** connected. The generator frequency shall start to decrease towards the new Nominal Frequency (47.5 Hz or 57.5 Hz).
17. SW2 is then adjusted further to ensure Governor Drive reads within **75% to 85%**, the sign of the drive (+ or - percentage) does not matter. Note that any change made to the lower percentage will be the same for the upper percentage. For example, if the lower percentages from 70% to 75%, the upper will increase from 80% to 85%.

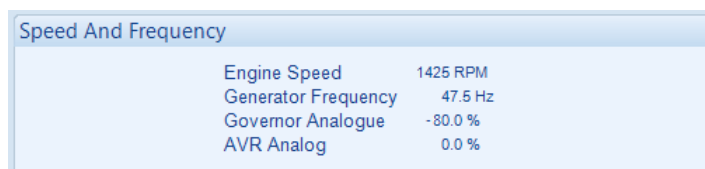

18. Change the setting of the Nominal Frequency back to the actual Nominal Frequency (50 Hz or 60 Hz).

8.2.1.2 DETERMINING CONNECTIONS AND SETTINGS FOR AVRS

NOTE: Determining the settings of SW1 and SW2 for the AVR **MUST** only be done once the setup for SW1 and SW2 for the governor has been complete. Changing engine speed affects the level of voltage produced.

Setting up the AVR (Adjustment of SW1 and SW2)

Before You Start

1. Ensure that the generator is connected to a **DEAD BUS BAR WITH NO LOADS** connected.
2. With the generator breaker open, set the generator to run at the **Nominal Voltage** without the DSE module connected to the AVR. To achieve this you will have to adjust the settings on the AVR.
3. Connect the DSE module to the AVR once completed. The DSE controller connects only to the “-” and “IN” terminals and provides the varying DC voltage to simulate the turning of a potentiometer. The Analogue output terminals of the DSE controller are connected as follows. Note that the “+” terminal of the AVR is left unconnected.

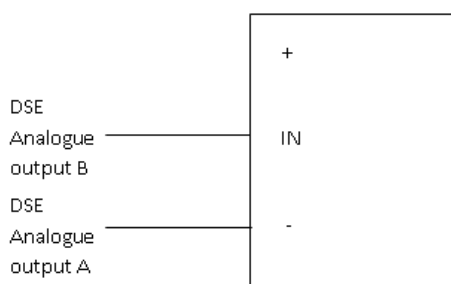

Adjustment of AVR SW1

4. Start the generator and ensure that the breaker is left open.
5. Check the direction of drive by increasing and decreasing SW1. If the voltage increases whilst SW1 is being decreased tick the option 'Output Reversed'. If moving SW1 does not change the voltage, check the wiring to the AVR for faults.

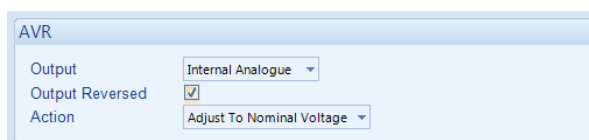

6. Adjust the SW1 setting for the AVR until the generator runs at **Nominal Voltage (230V for example)**.
7. Stop the generator. SW1 is now complete and needs to be left alone.

Adjustment of AVR SW2

8. Increase the setting of the Nominal Voltage by **10%** (230 v to 253 V for example)

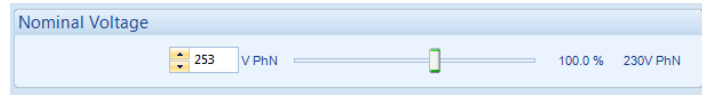

9. Start the generator. With the breaker open the generator will run at setting of SW1 (230V for example).
10. Close the generator breaker onto a **DEAD BUS BAR WITH NO LOADS** connected. The generator voltage shall start to increase towards the new Nominal Voltage setting (253V for example) however it may not achieve this.
11. Adjust SW2 to allow the voltage to increase to the new Nominal Voltage setting (253V for example)
12. Keep adjusting SW2 further to ensure AVR Drive reads within **75% to 85%**, the sign of the drive (+ or - percentage) does not matter.

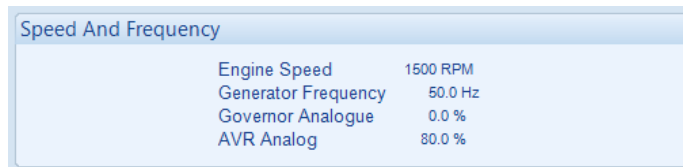

13. Stop the Generator
14. Decrease the setting of the Nominal Voltage by **10%** (207 V for example)

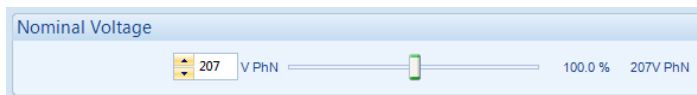

15. Start the generator. With the breaker open the generator will run at setting of SW1 (230V for example).
16. Close the generator breaker onto a **DEAD BUS BAR WITH NO LOADS** connected. The generator voltage shall start to decrease towards the new Nominal Voltage (207 V for example).
17. SW2 is then adjusted further to ensure AVR Drive reads within **75% to 85%**, the sign of the drive (+ or - percentage) does not matter. Note that any change made to the lower percentage will be the same for the upper percentage. For example, if the lower percentages from 70% to 75%, the upper will increase from 80% to 85%.

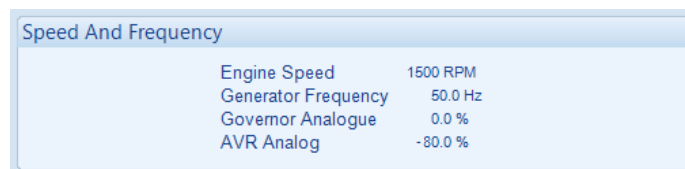

18. Change the setting of the Nominal Voltage back to the actual Nominal Voltage (230 V for example).

8.2.2 METERING

 **CAUTION!** Failure to perform the Metering steps results in incorrect power factor and kW calculations leading to problems with kW and kvar load sharing if not corrected.

 **WARNING!** Steps must be taken to ensure that when a CT is open circuit, the system/generator is in a safe state to work around.

8.2.2.1 CTS ON THE RIGHT PHASE

Check to ensure that the CTs on L1, L2 & L3 are connected to their respective connection on the DSE module.

This is tested by loading the mains with a purely resistive load (around 10% of the mains's size) across the three phases. If the CTs are wired correctly to the DSE module, it displays unity power factor (1.0 pf) across all three phases. If unity power factor is not displayed the CTs have been wired to the wrong phases on the DSE module.

8.2.2.2 CTS IN THE RIGHT DIRECTION

 **NOTE:** Checking that the CTs are on the right phase **MUST** be completed prior to checking if the CTs are in the correct direction. CTs on the wrong phase also cause negative kW.

Check to ensure that the CTs on L1, L2 & L3 have been mounted for the correct orientation for current flow and that the S1 and S2 have not been swapped over.

This is tested by loading the mains with a purely resistive load (around 10% of the mains's size) across the three phases. If the CTs' S1 and S2 are wired to correctly to the DSE module, it displays positive kW. If negative kW is displayed the CTs' S1 and S2 have been swapped around.

8.2.3 COMMUNICATIONS

⚠ CAUTION!: Failure to perform the Communications steps results in the controllers being unable to communicate to the other DSE controllers leading to problems during load sharing.

📌 NOTE: For further details of module configuration, refer to DSE Publication: 057-257 *DSE8660 MKII Configuration Suite Software Manual*.

Check to ensure that all the modules are connected are communicating correctly on the MSC link and Redundant MSC (if used).

This is tested by connecting the DSE module to a PC with the DSE Configuration Suite PC Software installed and going to the *SCADA | Bus | MSC Link* section. The information shown in this section changes dynamically depending on whether the MSC Link or Redundant MSC Link is in use. The number of *Sets On The Bus* must be the same as the number of DSE8x10s on the link. The number of *Mains Controllers ON The Bus* must be the same as the combined number of DSE8x60s and DSE8x80s on the link.

Multiset	
Bus	
Sets On The Bus	3
Mains Controllers On The Bus	2

If these numbers do not match up there is a fault on the active link. To find the module with the fault, connect into each module individually until the *Sets On The Bus* or *Mains Controllers On The Bus* reports 1.

If these numbers do match up, then the link which is currently in use is working correctly. To test the other link, remove the active link connection from any module. All the modules should then alarm with the same number link failure (*MSC 1 Link Failure* or *MSC 2 Link Failure*). If all the modules do not have the same number link failure then at some point the MSC and CAN connections have been crossed. If all the modules do have the same number link failure, the communication is automatically transferred onto the other link. Check the numbers in SCADA again to ensure the other link is operating correctly.

8.2.4 SYNC CHECKS

⚠ CAUTION! Failure to perform the Metering steps results in in serious damage to the system (breakers, bus bars, alternators, engines etc) caused by out of sync closures.

Check to ensure that all the module's sensing cables have been connected to the correct phases and that the generator bus' load switch has been correctly connected. Failing to perform such tests may lead to the DSE module sensing both sides of the breaker as in sync

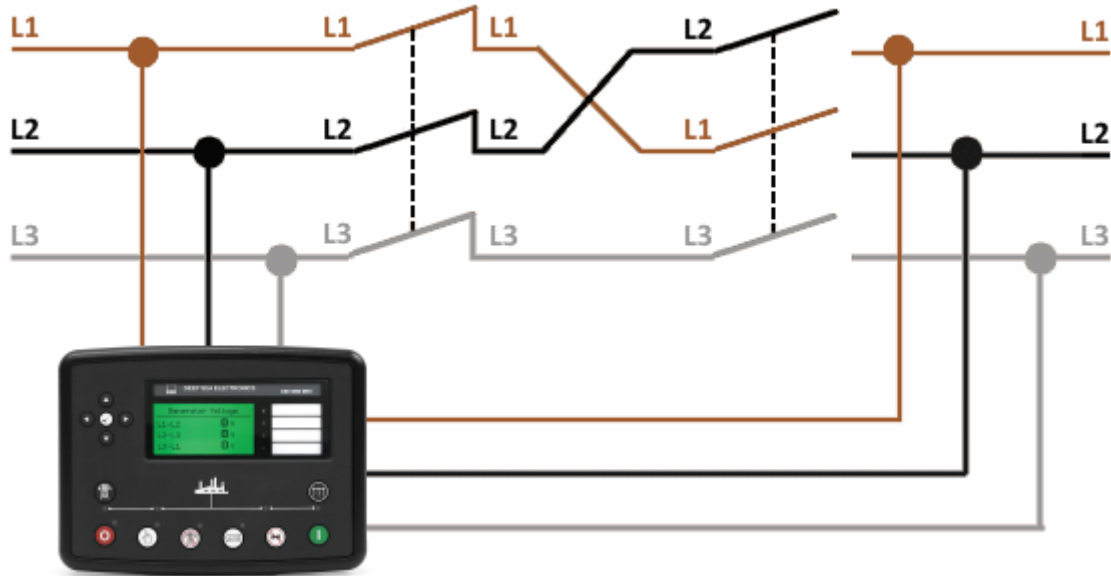

This is tested by starting the generator bus with the DSE8x60 module and ensuring the generator bus load switch is left open (activate an input configured for *Bus Load Inhibit*). Then the load section is to be made live, this is achieved by applying mains voltage to the unit so that the mains load switch closes. Across the open bus load switch, connect a voltage meter to measure the AC voltage when the DSE module shows the two supplies in sync.

8.2.4.1 INCORRECTLY WIRED BREAKER

When the DSE module's synchroscope shows the two supplies in sync, if the voltage meter shows a voltage difference the breaker is wired incorrectly. This is shown in the example below.

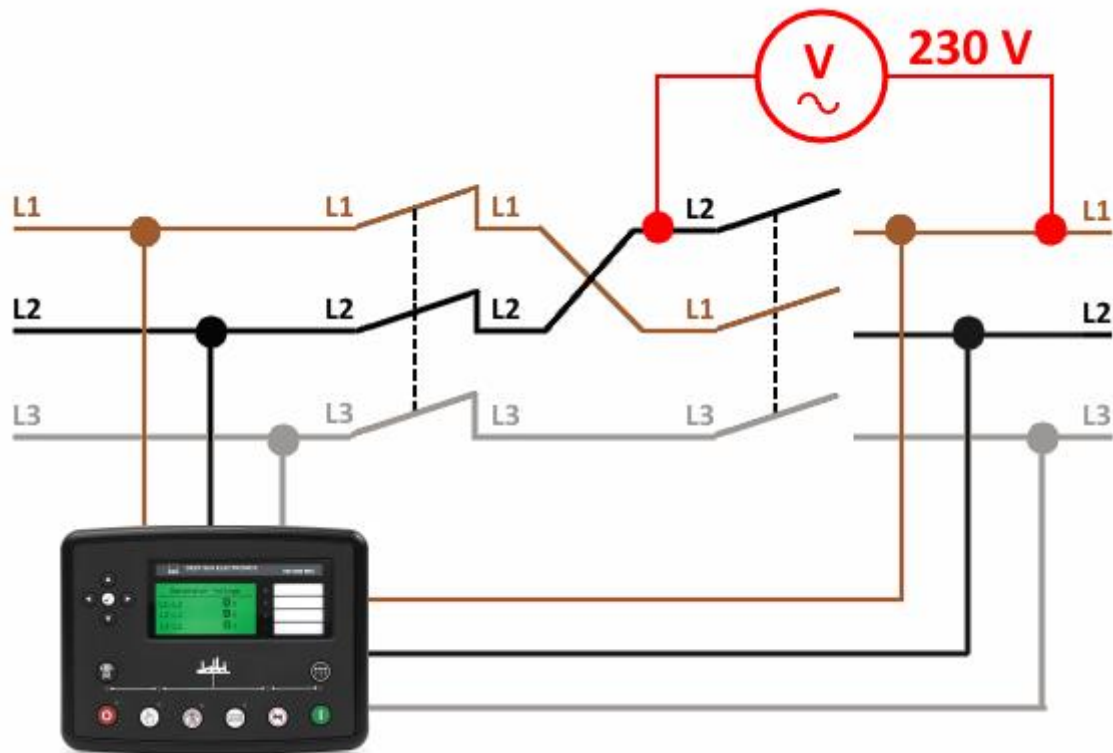
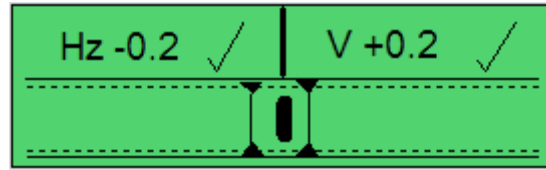

8.2.4.2 CORRECTLY WIRED BREAKER

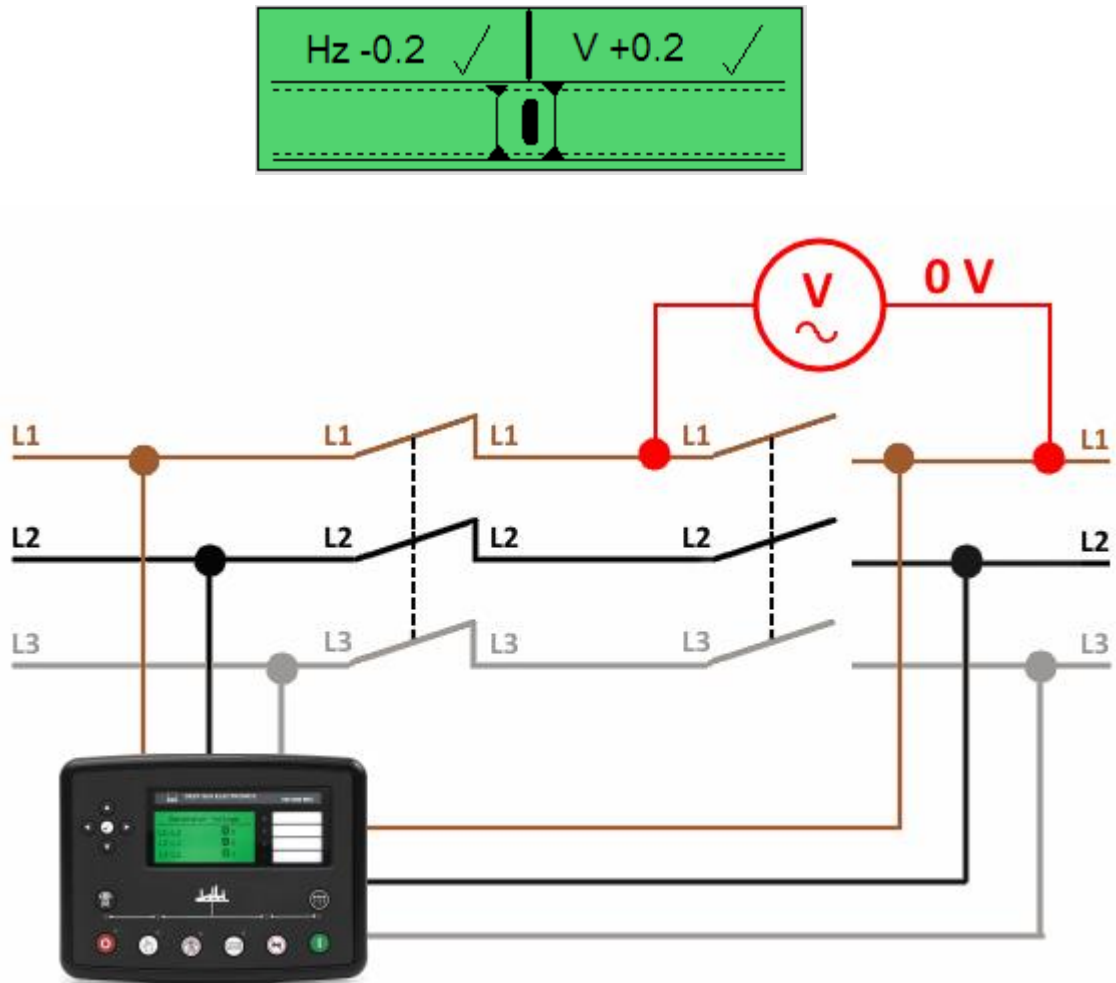

When the DSE module's synchroscope shows the two supplies in sync, if the voltage meter shows no voltage difference the breaker is wired correctly. This is shown in the example below.



9 FAULT FINDING

 **NOTE:** The below fault finding is provided as a guide check-list only. As the module can be configured to provide a wide range of different features, always refer to the source of the module configuration if in doubt.



9.1 STARTING

Symptom	Possible Remedy
Unit is inoperative Read/Write configuration does not operate	Check: <ul style="list-style-type: none"> • The battery and wiring to the unit. • The DC supply. • The DC fuse.
Unit shuts down	Check: <ul style="list-style-type: none"> • DC supply voltage is not above 35 V or below 8 V • The operating temperature is not above 70 °C. • The DC fuse.
Fail to Start is activated on DSE8x10 after pre-set number of attempts to start	Check: <ul style="list-style-type: none"> • Wiring of fuel solenoid. • Fuel supply. • Battery supply. • Battery supply is present on the Fuel output of the module. • The speed-sensing signal is present on the module's inputs. Refer to engine manual.
Continuous starting of generator when in Auto Mode 	Check: <ul style="list-style-type: none"> • That there is no signal present on the "Remote Start" input. • Input polarity is correct correctly. • The mains supply is available and within configured limits
Generator fail to start on receipt of Remote Start signal.	Check: <ul style="list-style-type: none"> • Start Delay timer has timed out. • Signal is on "Remote Start" input. Confirm correct configuration of input is configured to be used as "Remote Start". • MSC link operation • The DSE8x60 and DSE8x10 modules are in Auto Mode 

9.2 INSTRUMENTS

Symptom	Possible Remedy
Inaccurate measurements on controller display	<p>Check:</p> <ul style="list-style-type: none"> • That the CT primary, CT secondary and VT ratio settings are correct for the application. • That the CTs are wired correctly with regards to the direction of current flow (p1,p2 and s1,s2) and additionally ensure that CTs are connected to the correct phase (errors occur if CT1 is connected to phase 2). • Remember to consider the power factor: (kW = kV A x Power Factor) • The DSE8xxx MKII modules are true RMS measuring so gives more accurate display when compared with an 'averaging' meter such as an analogue panel meter or some lower specified digital multimeters. • Accuracy of the controller is better than 1% of full scale. Voltage full scale is 415 V AC ph-N so accuracy is ± 4.15 V (1% of 415 V).

9.3 LOADING

Symptom	Possible Remedy
Bus does not take load	<p>Check:</p> <ul style="list-style-type: none"> • The generator bus available LED is lit • That the output configuration is correct to drive the generator bus switch and that all connections are correct. • Remember that the generator bus does not take load in Manual Mode  unless the mains supply fails, a remote start on load input is present or the Transfer to Generator Bus  is pressed.
Inaccurate measurements on controller display	<p>Check:</p> <ul style="list-style-type: none"> • That the CT primary, CT secondary and VT ratio settings are correct for the application. • That the CTs are wired correctly with regards to the direction of current flow (p1,p2 and s1,s2) and additionally ensure that CTs are connected to the correct phase (errors occur if CT1 is connected to phase 2). • Remember to consider the power factor: (kW = kV A x Power Factor) • The DSE8xxx MII modules are true RMS measuring so gives more accurate display when compared with an 'averaging' meter such as an analogue panel meter or some lower specified digital multimeters. • Accuracy of the controller is better than 1% of full scale. Voltage full scale is 415 V AC ph-N so accuracy is ± 4.15 V (1% of 415 V).

9.4 COMMUNICATIONS

Symptom	Possible Remedy
RS232 connection to PC inoperative	<p>Check :</p> <ul style="list-style-type: none"> • RS232 maximum of 15 m is not exceeded • Direct to PC connection requires a Crossover (NULL modem) RS232 cable • Baud rate of controller and of master device are the same • Slave ID of the controller is the same as configured in the master device
RS232 connection to GSM modem inoperative	<p>Check :</p> <ul style="list-style-type: none"> • RS232 maximum of 15 m is not exceeded • Modem Initialisation strings in the DSE configuration is correct for the connected modem type • Modem is configured to 9600 baud • SIM card is CSD (circuit switched data) compatible • SIM card is not PIN locked • SIM card is correctly inserted • Antenna is correctly installed and is not inside an earthed metal cabinet / control panel • A good signal is available in the locality
RS232 connection to landline modem inoperative	<p>Check :</p> <ul style="list-style-type: none"> • RS232 maximum of 15 m is not exceeded • Modem Initialisation strings in the DSE configuration is correct for the connected modem type • Modem is configured to 9600 baud
RS485 inoperative	<p>Check:</p> <ul style="list-style-type: none"> • Connection cable – Belden 9841 or equivalent • 120 Ω termination resistors are correctly fitted • Baud rate of controller and of master device are the same • Slave ID of the controller is the same as configured in the master device
DSENet inoperative	<p>Check:</p> <ul style="list-style-type: none"> • Connection cable – Belden 9841 or equivalent • 120 Ω termination resistors are correctly fitted to the last expansion module only. • Slave ID of the expansion module is the same as configured in the modules configuration.
Ethernet comms direct to PC inoperative	<p>Check :</p> <ul style="list-style-type: none"> • Ethernet rated cable is used • Check the IP address of the DSE controller is correct • Check the PC is not set to obtain IP address automatically • Check PC firewall allows traffic on the configured port.
Ethernet connected to a router.	<p>Check :</p> <ul style="list-style-type: none"> • Ethernet rated cable is used • Check the IP address of the DSE controller is correct • Check all firewalls and routers allow traffic on the configured port. • Test the controller connected directly to a PC for test purposes to eliminate router problems.

9.5 SYNCHRONISING & LOAD SHARING

Symptom	Possible Remedy
Synchronising not available	Check Synchronising is enabled in the configuration suite software Generator, Synchronising section
Generator does not loadshare correctly	Ensure that all the DSE Four Steps to Synchronising have been completed. Check kW Share & kvar Share are enabled, check generator rating is correctly configured in the DSE configuration suite PC Software and check the MSC link is connected correctly.
Synchronising or load sharing is not operating satisfactorily	Follow the DSE "4 Steps To Synchronising" as detailed in the following section.

9.6 MISCELLANEOUS

Symptom	Possible Remedy
Module appears to 'revert' to an earlier configuration	<p>When editing a configuration using the PC software it is vital that the configuration is first 'read' from the controller before editing it. This edited configuration must then be "written" back to the controller for the changes to take effect.</p> <p>When editing a configuration using the fascia editor, be sure to exit the editor by pressing Tick  button to save changes</p>

10 MAINTENANCE, SPARES, REPAIR AND SERVICING

The controller is *Fit and Forget*. As such, there are no user serviceable parts within the controller. In the case of malfunction, you should contact your original equipment manufacturer (OEM).







10.1 PURCHASING ADDITIONAL CONNECTOR PLUGS FROM DSE

If you require additional plugs from DSE, please contact our Sales department using the part numbers below.

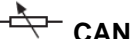
10.1.1 PACK OF PLUGS

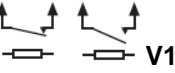
Module Type	Plug Pack Part Number
DSE86xx MKII	007-891

10.1.2 INDIVIDUAL PLUGS

Module Terminal Designation	Plug Description	Part No.
1 to 14 	14 way 5.08 mm	007-428
15 to 22  CAN	8 way 5.08 mm	007-164
23 to 39  ECU  MSC GOV AVR	17 way 5.08 mm	007-452
40 to 47  V1	8 way 7.62 mm	007-454
48 to 51 V2	4 way 7.62 mm	007-171
52 to 58 	7 way 5.08 mm	007-447
59 to 70 	12 way 5.08 mm	007-109
71 to 76 RS485 Port 1 Port 2	6 way 5.08 mm	007-446
	PC Configuration interface lead (USB type A – USB type B)	016-125

10.2 PURCHASING ADDITIONAL FIXING CLIPS FROM DSE

Item	Description	Part No.
	Module Fixing Clips (Packet of 4)	020-294

10.3 PURCHASING ADDITIONAL SEALING GASKET FROM DSE

Item	Description	Part No.
	Module Silicon Sealing Gasket	020-564







10.4 PURCHASING REAR MOUNT PANEL BRACKET FROM DSE

Item	Description	Part No.
	Rear Mount Panel Bracket	020-1044

10.5 DSENET® EXPANSION MODULES

NOTE: A maximum of twenty (20) expansion modules can be connected to the DSE8660 MKII DSENet® Port

NOTE: DSENet® utilises an RS485 connection. Using Belden 9841 (or equivalent) cable allows for the expansion cable to be extended to a maximum of 1.2 km. DSE Stock and supply Belden 9841 cable. DSE Part Number 016-030.

Item	Max No. Supported	Description	DSE Part Numbers		
			Model Order Number	Operator Manual	Installation Instructions
	4	Model DSE2130 input module provides additional analogue and digital inputs for use with the controller.	2130-00	055-060	057-082
	4	Model DSE2131 Ratio-metric input expansion module provides additional restive, digital, 0-10V and 4-20ma inputs for use with the controller.	2131-00	055-115	057-139
	4	Model DSE2133 RTD/Thermocouple input expansion module provides additional RTD and thermocouple inputs for use with the controller.	2133-00	055-114	057-140
	4	Model DSE2152 Ratio-metric output expansion module provides additional 0-10V and 4-20ma outputs for use with the controller.	2152-00	055-112	057-141
	10	Model DSE2157 expansion relay module provides eight additional voltage free relays for use with the controller	2157-00	055-061	057-083
	10	Model DSE2548 expansion LED module provides additional LED indications, internal sounder and remote lamp test/alarm mute for use with the controller.	2548-00	057-084	053-032
	4	DSE Intelligent Battery Charger monitored by the controller	Various DSE Intelligent Battery Chargers are supported, contact DSE Technical Support; support@deepseaelectronics.com for further details.		

11 WARRANTY

DSE Provides limited warranty to the equipment purchaser at the point of sale. For full details of any applicable warranty, refer to the original equipment supplier (OEM)

12 DISPOSAL

12.1 WEEE (WASTE ELECTRICAL AND ELECTRONIC EQUIPMENT)

If you use electrical and electronic equipment you must store, collect, treat, recycle and dispose of WEEE separately from your other waste



This Page is Intentionally Blank

This Page is Intentionally Blank